

Precision, Zero-Drift, Rail-to-Rail Out, High-Voltage(32V) Operational Amplifier

1 FEATURES

- **Gain-Bandwidth Product: 2.0MHz**
- **Low Offset Voltage: 50 μ V (Max)**
- **Input Offset Drift: $\pm 0.15\mu$ V/ $^{\circ}$ C**
- **Low Input Noise: 0.6 μ Vpp (0.1Hz to 10Hz)**
- **Low Supply Current: 0.9mA/Amp (TYP)**
- **Rail to Rail Output**
- **Excellent DC Precision:**
 - PSRR: 130dB
 - CMRR: 120dB
 - Open-Loop Gain: 130dB
- **Single-Supply Operation: 3.3V to 32V**
- **Dual-Supply Operation: ± 1.65 V to ± 16 V**
- **Specified Up to +125 $^{\circ}$ C**
- **Micro Size Packages: SOP8, MSOP8, SOP14**

2 APPLICATIONS

- **Temperature Measurements**
- **Semiconductor Test**
- **Pressure Sensors**
- **Medical Equipment**
- **Test Equipment**
- **Driving A/D Converters**
- **Precision Current Sensing**

3 DESCRIPTIONS

The RS865X series of CMOS operational amplifiers use auto-zero techniques to simultaneously provide very low offset voltage (50 μ V max) and near-zero drift over time and temperature. This family of amplifiers has ultra-low noise, offset and power.

This miniature, high-precision operational amplifiers offer high input impedance and rail-to-rail output swing. With high gain-bandwidth product of 2.0MHz and slew rate of 1.0V/ μ s. Either single or dual supplies can be used in the range from 3.3V to 32V (± 1.65 V to ± 16 V).

The RS865X families of operational amplifiers are specified at the full temperature range of -40 $^{\circ}$ C to +125 $^{\circ}$ C.

Device Information ⁽¹⁾

PART NUMBER	PACKAGE	BODY SIZE(NOM)
RS8652	SOP8	4.90mm x 3.90mm
	MSOP8	3.00mm x 3.00mm
RS8654	SOP14	8.65mm x 3.90mm

(1) For all available packages, see the orderable addendum at the end of the data sheet.

Table of Contents

1 FEATURES	1
2 APPLICATIONS	1
3 DESCRIPTIONS	1
4 REVISION HISTORY	3
5 PACKAGE/ORDERING INFORMATION ⁽¹⁾	4
6 PIN CONFIGURATION AND FUNCTIONS	5
7 SPECIFICATIONS	7
7.1 Absolute Maximum Ratings	7
7.2 ESD Ratings	7
7.3 Recommended Operating Conditions.....	7
7.4 Electrical Characteristics.....	8
7.5 Typical Characteristics	10
8 PACKAGE OUTLINE DIMENSIONS	13
9 TAPE AND REEL INFORMATION	16

4 REVISION HISTORY

Note: Page numbers for previous revisions may differ from page numbers in the current version.

VERSION	Change Date	Change Item
A.1	2024/12/25	Initial version completed

5 PACKAGE/ORDERING INFORMATION ⁽¹⁾

Orderable Device	Package Type	Pin	Channel	Op Temp(°C)	Device Marking ⁽²⁾	MSL ⁽³⁾	Package Qty
RS8652XK	SOP8	8	2	-40°C ~125°C	RS8652	MSL3	Tape and Reel, 4000
RS8652XM	MSOP8	8	2	-40°C ~125°C	RS8652	MSL3	Tape and Reel, 4000
RS8654XP	SOP14	14	4	-40°C ~125°C	RS8654	MSL3	Tape and Reel, 4000

NOTE:

- (1) This information is the most current data available for the designated devices. This data is subject to change without notice and revision of this document. For browser-based versions of this data sheet, refer to the right-hand navigation.
- (2) There may be additional marking, which relates to the lot trace code information (data code and vendor code), the logo or the environmental category on the device.
- (3) Runic classify the MSL level with using the common preconditioning setting in our assembly factory conforming to the JEDEC industrial standard J-STD-20F. Please align with Runic if your end application is quite critical to the preconditioning setting or if you have special requirement.

6 PIN CONFIGURATION AND FUNCTIONS

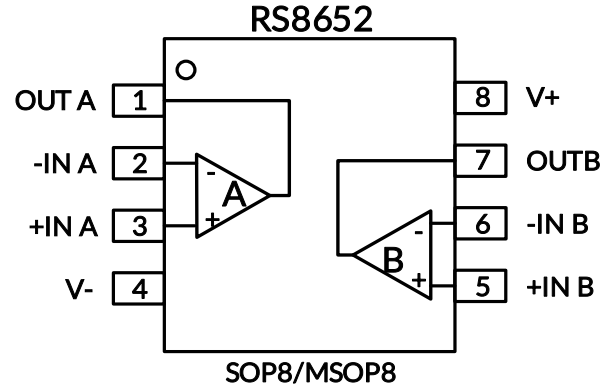

PIN DESCRIPTION

NAME	PIN	I/O ⁽¹⁾	DESCRIPTION
	SOP8/MSOP8		
-INA	2	I	Inverting input, channel A
+INA	3	I	Noninverting input, channel A
-INB	6	I	Inverting input, channel B
+INB	5	I	Noninverting input, channel B
OUTA	1	O	Output, channel A
OUTB	7	O	Output, channel B
V-	4	-	Negative (lowest) power supply or ground (for single supply operation)
V+	8	-	Positive (highest) power supply

(1) I = Input, O = Output.

PIN CONFIGURATION AND FUNCTIONS

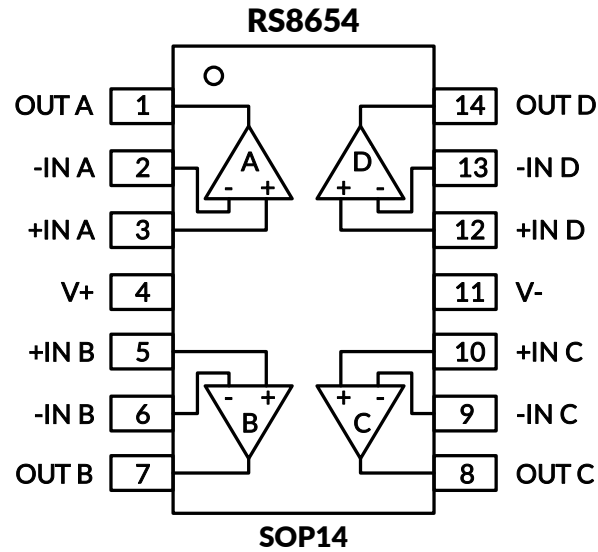

PIN DESCRIPTION

NAME	PIN	I/O ⁽¹⁾	DESCRIPTION
	SOP14		
-INA	2	I	Inverting input, channel A
+INA	3	I	Noninverting input, channel A
-INB	6	I	Inverting input, channel B
+INB	5	I	Noninverting input, channel B
-INC	9	I	Inverting input, channel C
+INC	10	I	Noninverting input, channel C
-IND	13	I	Inverting input, channel D
+IND	12	I	Noninverting input, channel D
OUTA	1	O	Output, channel A
OUTB	7	O	Output, channel B
OUTC	8	O	Output, channel C
OUTD	14	O	Output, channel D
V-	11	-	Negative (lowest) power supply
V+	4	-	Positive (highest) power supply

(1) I = Input, O = Output.

7 SPECIFICATIONS

7.1 Absolute Maximum Ratings

Over operating free-air temperature range (unless otherwise noted) ⁽¹⁾

			MIN	MAX	UNIT
Voltage	Supply, $V_S=(V+) - (V-)$	Dual supply		±18	V
		Single supply		36	
	Signal input pin ⁽²⁾	Common-mode voltage	(V-)-0.5	(V+) +0.5	
		Differential voltage		±0.7	
	Signal output pin ⁽³⁾		(V-)-0.5	(V+) +0.5	
Current	Signal input pin ⁽²⁾		-10	10	mA
	Signal output pin ⁽³⁾		-50	50	mA
	Output short-circuits ⁽⁴⁾	Continuous			
θ_{JA}	Package thermal impedance ⁽⁵⁾	SOP8		110	°C/W
		MSOP8		170	
		SOP14		105	
Temperature	Operating range, T_A		-40	125	°C
	Junction, T_J ⁽⁶⁾		-40	150	
	Storage, T_{stg}		-65	150	

(1) Stresses above these ratings may cause permanent damage. Exposure to absolute maximum conditions for extended periods may degrade device reliability. These are stress ratings only, and functional operation of the device at these or any other conditions beyond those specified is not implied.

(2) Input terminals are diode-clamped to the power-supply rails. Input signals that can swing more than 0.5V beyond the supply rails should be current-limited to 10mA or less.

(3) Output terminals are diode-clamped to the power-supply rails. Output signals that can swing more than 0.5V beyond the supply rails should be current-limited to ±50mA or less.

(4) Short-circuit to ground, one amplifier per package.

(5) The package thermal impedance is calculated in accordance with JESD-51.

(6) The maximum power dissipation is a function of $T_{J(MAX)}$, $R_{\theta JA}$, and T_A . The maximum allowable power dissipation at any ambient temperature is $P_D = (T_{J(MAX)} - T_A) / R_{\theta JA}$. All numbers apply for packages soldered directly onto a PCB.

7.2 ESD Ratings

The following ESD information is provided for handling of ESD-sensitive devices in an ESD protected area only.

			VALUE	UNIT
$V_{(ESD)}$	Electrostatic discharge	Human-Body Model (HBM), per ANSI/ESDA/JEDEC JS-001 ⁽¹⁾	±2500	V
		Charged-Device Model (CDM), per ANSI/ESDA/JEDEC JS-002 ⁽²⁾	±1500	
		Machine Model (MM)	±500	

(1) JEDEC document JEP155 states that 500 V HBM allows safe manufacturing with a standard ESD control process.

(2) JEDEC document JEP157 states that 250 V CDM allows safe manufacturing with a standard ESD control process.



ESD SENSITIVITY CAUTION

ESD damage can range from subtle performance degradation to complete device failure. Precision integrated circuits may be more susceptible to damage because very small parametric changes could cause the device not to meet its published specifications.

7.3 Recommended Operating Conditions

Over operating free-air temperature range (unless otherwise noted)

		MIN	NOM	MAX	UNIT
Supply voltage, $V_S= (V+) - (V-)$	Single-supply	3.3		32	V
	Dual-supply	±1.65		±16	

7.4 Electrical Characteristics

At $T_A = +25^\circ\text{C}$, $V_S = 3.3\text{V}$ to 32V , $R_L = 10\text{k}\Omega$ connected to $V_S/2$, and $V_{CM} = V_{OUT} = V_S/2$, Full ⁽⁹⁾ = -40°C to $+125^\circ\text{C}$ (unless otherwise noted)⁽¹⁾

PARAMETER		CONDITIONS	T_J	RS8652, RS8654			UNIT
				MIN ⁽²⁾	TYP ⁽³⁾	MAX ⁽²⁾	
POWER SUPPLY							
V_S	Operating Voltage Range		25°C	3.3		32	V
IQ	Quiescent Current Per Amplifier	$V_S = \pm 2.5\text{V}$, $I_o = 0\text{mA}$	25°C		0.9	1.25	mA
			Full			1.5	
		$V_S = \pm 16\text{V}$, $I_o = 0\text{mA}$	25°C		1.1	2.0	
			Full			2.5	
PSRR	Power-Supply Rejection Ratio	$V_S = 5\text{V}$ to 32V	25°C	110	130		dB
			Full	100			
INPUT							
Vos	Input Offset Voltage	$V_{CM} = V_S/2$	25°C	-50	± 3	50	μV
			Full		± 25		
$V_{os} T_c$	Input Offset Voltage Average Drift	$V_{CM} = V_S/2$	Full		± 0.15		$\mu\text{V}/^\circ\text{C}$
IB	Input Bias Current ⁽⁴⁾⁽⁵⁾	$V_{CM} = 0\text{V}$	25°C		100	1000	pA
			Full		600		
Ios	Input Offset Current ⁽⁴⁾	$V_{CM} = 0\text{V}$	25°C		100		pA
			Full		600		
V_{CM}	Common-Mode Voltage Range	$V_S = \pm 16\text{V}$	25°C	(V-)		(V+)-1.5	V
CMRR	Common-Mode Rejection Ratio	$V_S = \pm 16\text{V}$ $V_{CM} = (V-) + 0.3$ to $(V+) - 1.5\text{V}$	25°C	95	120		dB
			Full	90			
OUTPUT							
A _{OL}	Open-Loop Voltage Gain	$R_L = 10\text{k}\Omega$ $V_o = (V-) + 0.4\text{V}$ to $(V+) - 0.4\text{V}$	25°C	100	130		dB
			Full	90			
V_{OH}	Output Swing from Rail	$V_S = \pm 16\text{V}$, $R_L = 10\text{k}\Omega$	25°C	15.80			V
V_{OL}			25°C			-15.70	
I _{SC}	Short-Circuit Current ⁽⁶⁾⁽⁷⁾	$V_S = \pm 2.5\text{V}$, $V_o = 0\text{V}$ $V_S = \pm 16\text{V}$, $V_o = 0\text{V}$	25°C	15	20		mA
				60	80		
R_o	Open-loop Output Impedance ⁽⁴⁾	$f = 1\text{MHz}$, $I_o = 0\text{mA}$			120		Ω
C_{LOAD}	Capacitive Load Drive ⁽⁴⁾				1		nF
FREQUENCY RESPONSE							
SR	Slew Rate ⁽⁸⁾	$V_S = \pm 2.5\text{V}$, $G = +1$, $C_L = 100\text{pF}$	25°C		1.0		$\text{V}/\mu\text{s}$
GBW	Gain-Bandwidth Product	$V_S = \pm 2.5\text{V}$	25°C		2.0		MHz
t_s	Settling Time, 0.1%	$V_S = \pm 2.5\text{V}$, $G = +1$, $C_L = 100\text{pF}$, Step=2V	25°C		6.6		μs
t_{OR}	Overload Recovery Time	$V_{IN} \cdot \text{Gain} \geq V_S$, $G = -10$	25°C		1.6		μs
NOISE							
E_n	Input Voltage Noise	$f = 0.1\text{Hz}$ to 10Hz , $V_S = \pm 2.5\text{V}$	25°C		0.6		μV_{pp}
e_n	Input Voltage Noise Density ⁽⁴⁾	$f = 1\text{KHz}$	25°C		30		$\text{nV}/\sqrt{\text{Hz}}$
		$f = 10\text{KHz}$			14		

NOTE:

- (1) Electrical table values apply only for factory testing conditions at the temperature indicated. Factory testing conditions result in very limited self-heating of the device.
- (2) Limits are 100% production tested at 25°C. Limits over the operating temperature range are ensured through correlations using statistical quality control (SQC) method.
- (3) Typical values represent the most likely parametric norm as determined at the time of characterization. Actual typical values may vary over time and will also depend on the application and configuration.
- (4) This parameter is ensured by design and/or characterization and is not tested in production.
- (5) Positive current corresponds to current flowing into the device.
- (6) The maximum power dissipation is a function of $T_{J(MAX)}$, $R_{\theta JA}$, and T_A . The maximum allowable power dissipation at any ambient temperature is $P_D = (T_{J(MAX)} - T_A) / R_{\theta JA}$. All numbers apply for packages soldered directly onto a PCB.
- (7) Short circuit test is a momentary test.
- (8) Number specified is the slower of positive and negative slew rates.
- (9) Specified by characterization only.

7.5 Typical Characteristics

NOTE: The graphs and tables provided following this note are a statistical summary based on a limited number of samples and are provided for informational purposes only.

At $T_A = -40^{\circ}\text{C}$ to 125°C , $V_S = 5\text{V}$, $R_L = 10\text{k}\Omega$ connected to $V_S/2$, $V_{OUT} = V_S/2$, unless otherwise noted.

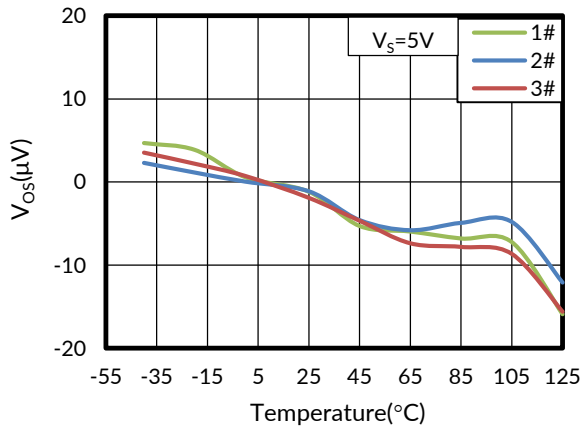

Figure 1. Offset Voltage vs Temperature

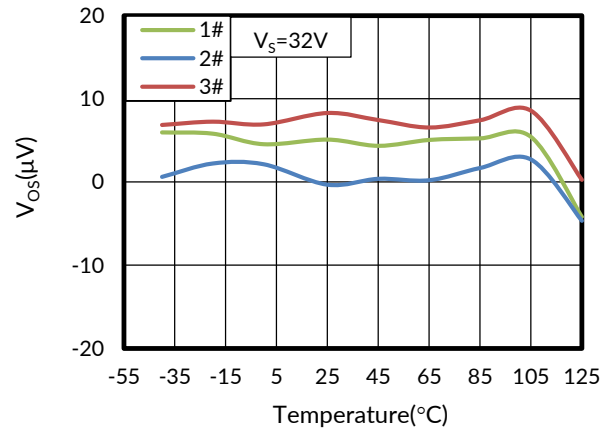

Figure 2. Offset Voltage vs Temperature

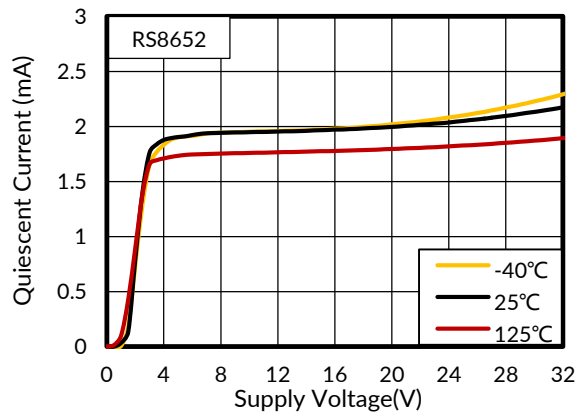

Figure 3. Supply Voltage vs Quiescent Current

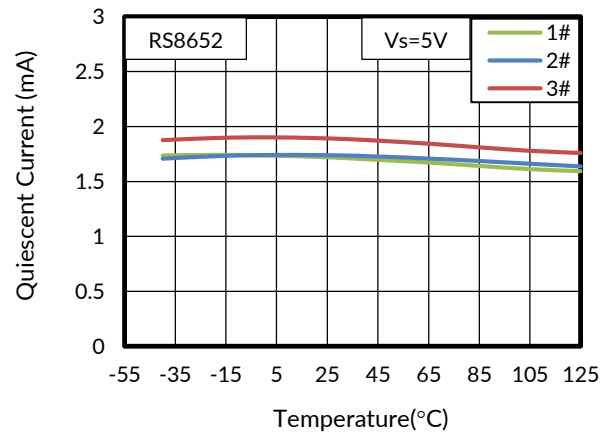

Figure 4. Quiescent Current vs Temperature

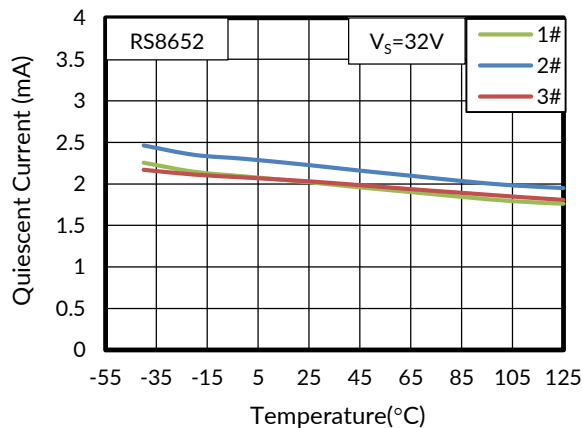

Figure 5. Quiescent Current vs Temperature

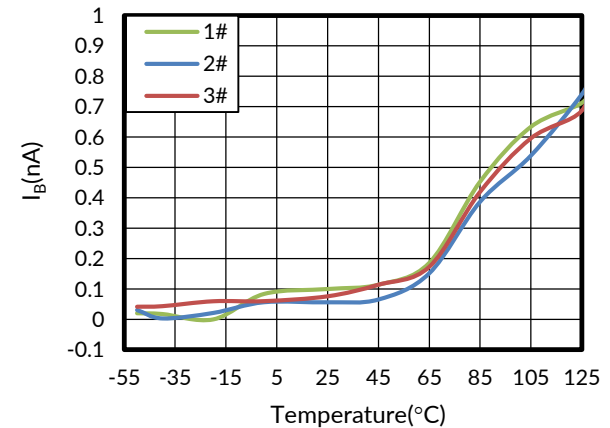

Figure 6. Input Bias Current vs Temperature

Typical Characteristics

NOTE: The graphs and tables provided following this note are a statistical summary based on a limited number of samples and are provided for informational purposes only.

At $T_A = -40^{\circ}\text{C}$ to 125°C , $V_S = 5\text{V}$, $R_L = 10\text{k}\Omega$ connected to $V_S/2$, $V_{OUT} = V_S/2$, unless otherwise noted.

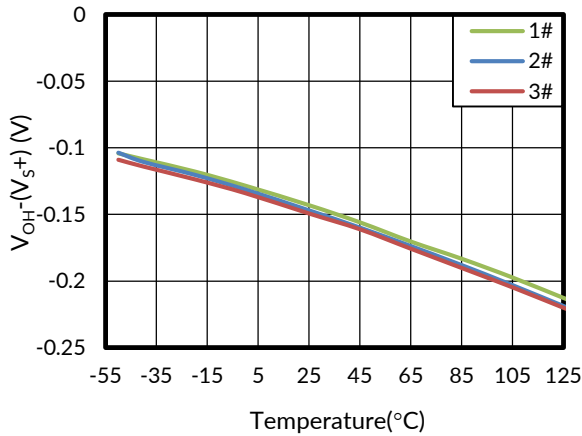

Figure 7. Output Swing from Rail vs Temperature

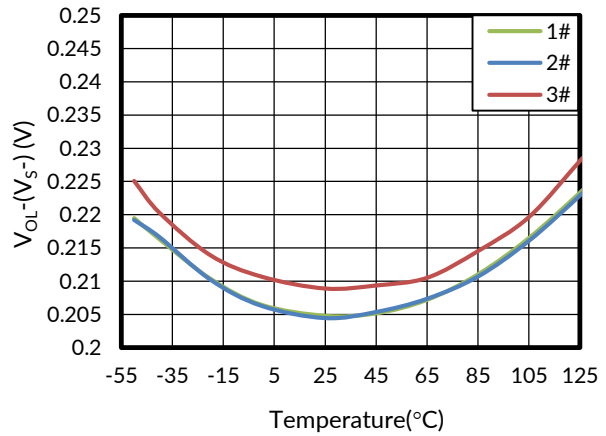

Figure 8. Output Swing from Rail vs Temperature

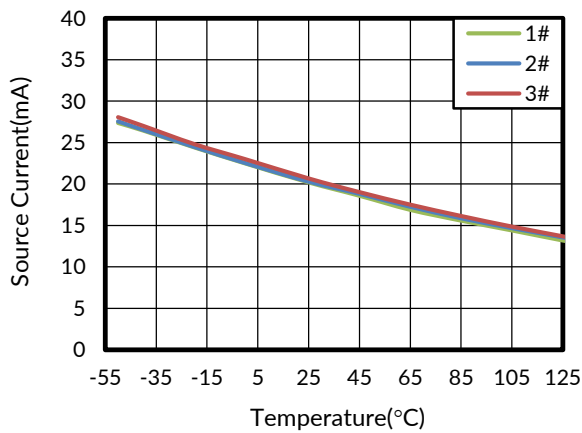

Figure 9. Source Current vs Temperature

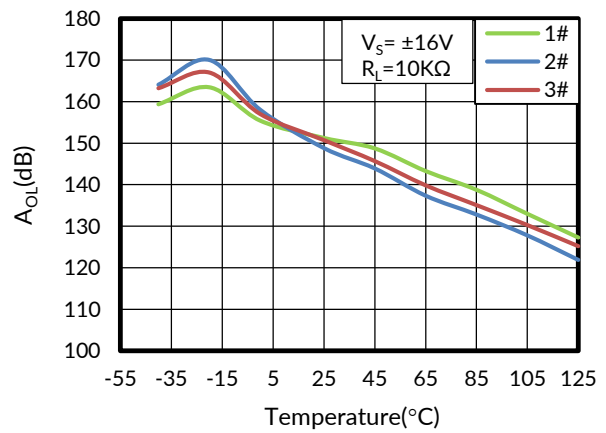

Figure 10. Open-Loop Gain vs Temperature

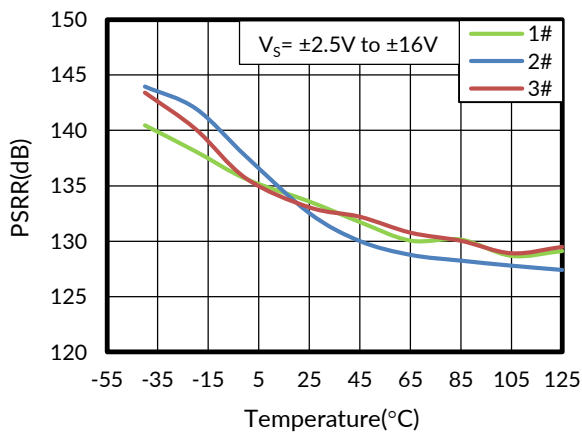

Figure 11. Power-Supply Rejection Ratio vs Temperature

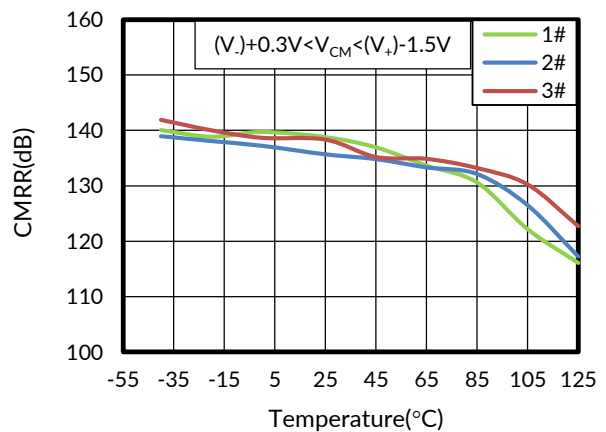

Figure 12. Common-Mode Rejection Ratio vs Temperature

Typical Characteristics

NOTE: The graphs and tables provided following this note are a statistical summary based on a limited number of samples and are provided for informational purposes only.

At $T_A = -40^{\circ}\text{C}$ to 125°C , $V_S = 5\text{V}$, $R_L = 10\text{k}\Omega$ connected to $V_S/2$, $V_{OUT} = V_S/2$, unless otherwise noted.

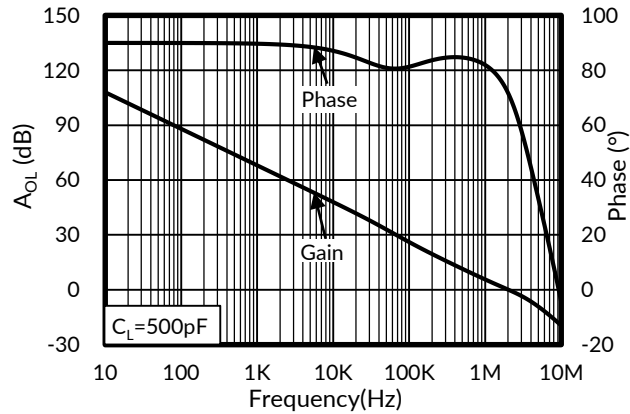
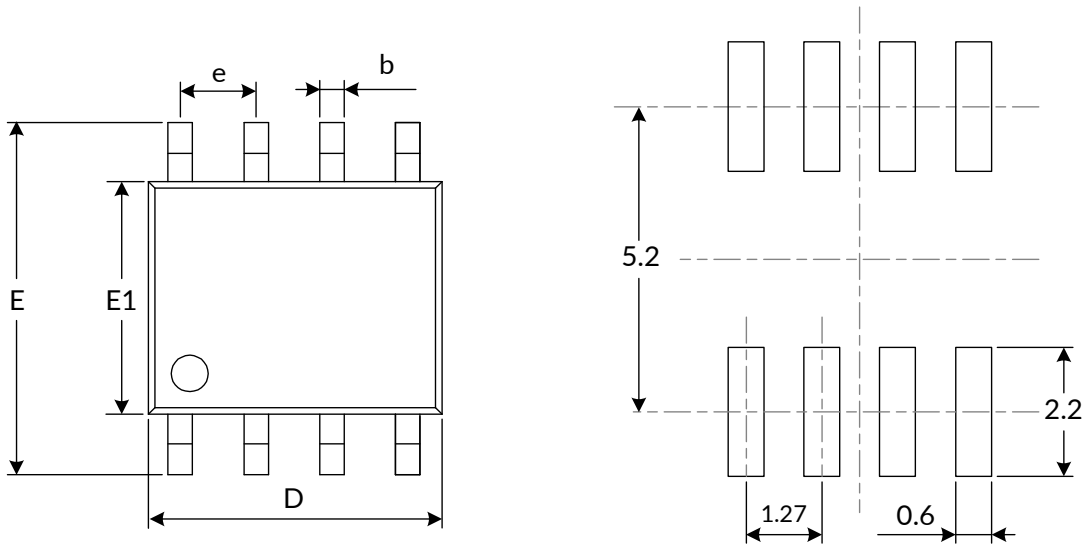
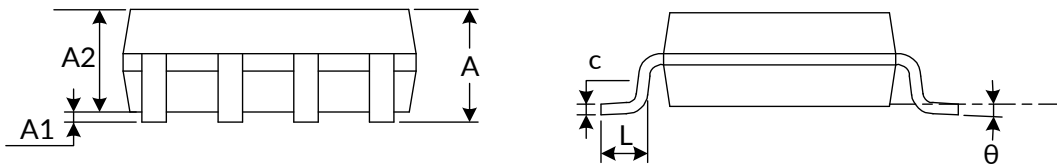

Figure 13. Open-Loop Gain and Phase vs Frequency

8 PACKAGE OUTLINE DIMENSIONS SOP8⁽³⁾

RECOMMENDED LAND PATTERN (Unit: mm)

Symbol	Dimensions In Millimeters		Dimensions In Inches	
	Min	Max	Min	Max
A ⁽¹⁾	1.350	1.750	0.053	0.069
A1	0.100	0.250	0.004	0.010
A2	1.350	1.550	0.053	0.061
b	0.330	0.510	0.013	0.020
c	0.170	0.250	0.007	0.010
D ⁽¹⁾	4.800	5.000	0.189	0.197
e	1.270(BSC) ⁽²⁾		0.050(BSC) ⁽²⁾	
E	5.800	6.200	0.228	0.244
E1 ⁽¹⁾	3.800	4.000	0.150	0.157
L	0.400	1.270	0.016	0.050
θ	0°	8°	0°	8°

NOTE:

1. Plastic or metal protrusions of 0.15mm maximum per side are not included.
2. BSC (Basic Spacing between Centers), "Basic" spacing is nominal.
3. This drawing is subject to change without notice.

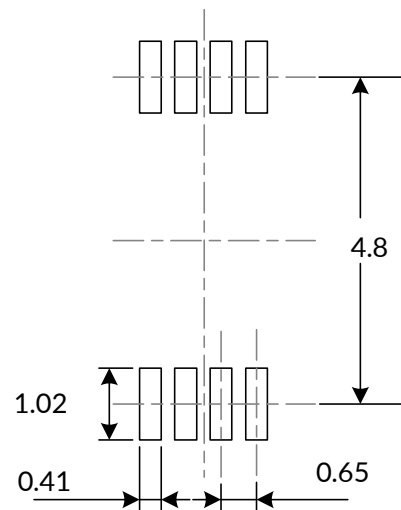
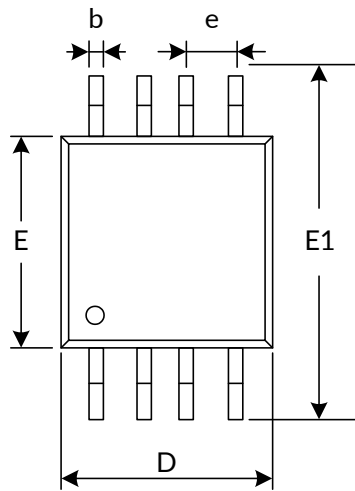
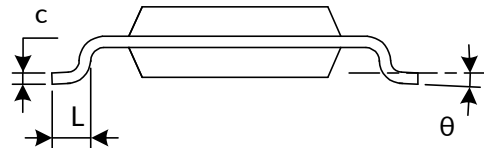
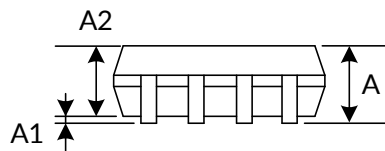
MSOP8⁽³⁾

RECOMMENDED LAND PATTERN (Unit: mm)

Symbol	Dimensions In Millimeters		Dimensions In Inches	
	Min	Max	Min	Max
A ⁽¹⁾	0.820	1.100	0.032	0.043
A1	0.020	0.150	0.001	0.006
A2	0.750	0.950	0.030	0.037
b	0.250	0.380	0.010	0.015
c	0.090	0.230	0.004	0.009
D ⁽¹⁾	2.900	3.100	0.114	0.122
e	0.650(BSC) ⁽²⁾		0.026(BSC) ⁽²⁾	
E ⁽¹⁾	2.900	3.100	0.114	0.122
E1	4.750	5.050	0.187	0.199
L	0.400	0.800	0.016	0.031
θ	0°	6°	0°	6°

NOTE:

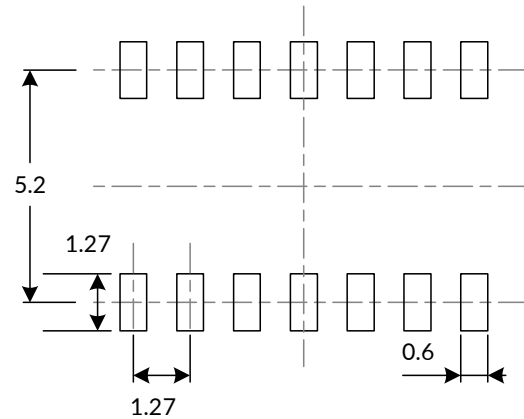
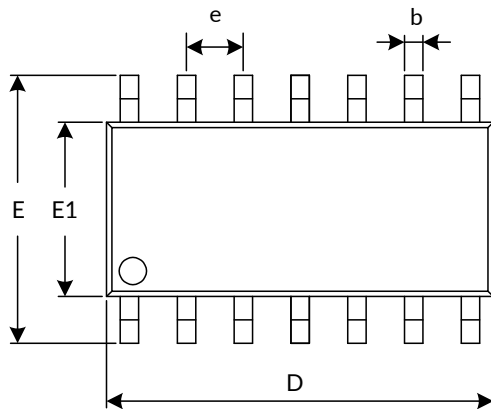
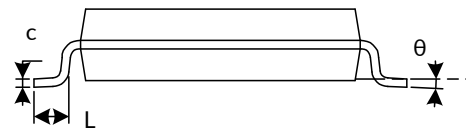
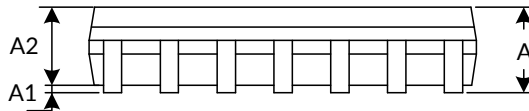
1. Plastic or metal protrusions of 0.15mm maximum per side are not included.
2. BSC (Basic Spacing between Centers), "Basic" spacing is nominal.
3. This drawing is subject to change without notice.

SOP14 (3)

RECOMMENDED LAND PATTERN (Unit: mm)

Symbol	Dimensions In Millimeters		Dimensions In Inches	
	Min	Max	Min	Max
A ⁽¹⁾	1.350	1.750	0.053	0.069
A1	0.100	0.250	0.004	0.010
A2	1.350	1.550	0.053	0.061
b	0.310	0.510	0.012	0.020
c	0.100	0.250	0.004	0.010
D ⁽¹⁾	8.450	8.850	0.333	0.348
e	1.270(BSC) ⁽²⁾		0.050(BSC) ⁽²⁾	
E	5.800	6.200	0.228	0.244
E1 ⁽¹⁾	3.800	4.000	0.150	0.157
L	0.400	1.270	0.016	0.050
θ	0°	8°	0°	8°

NOTE:

1. Plastic or metal protrusions of 0.15mm maximum per side are not included.
2. BSC (Basic Spacing between Centers), "Basic" spacing is nominal.
3. This drawing is subject to change without notice.

9 TAPE AND REEL INFORMATION

REEL DIMENSIONS

TAPE DIMENSION

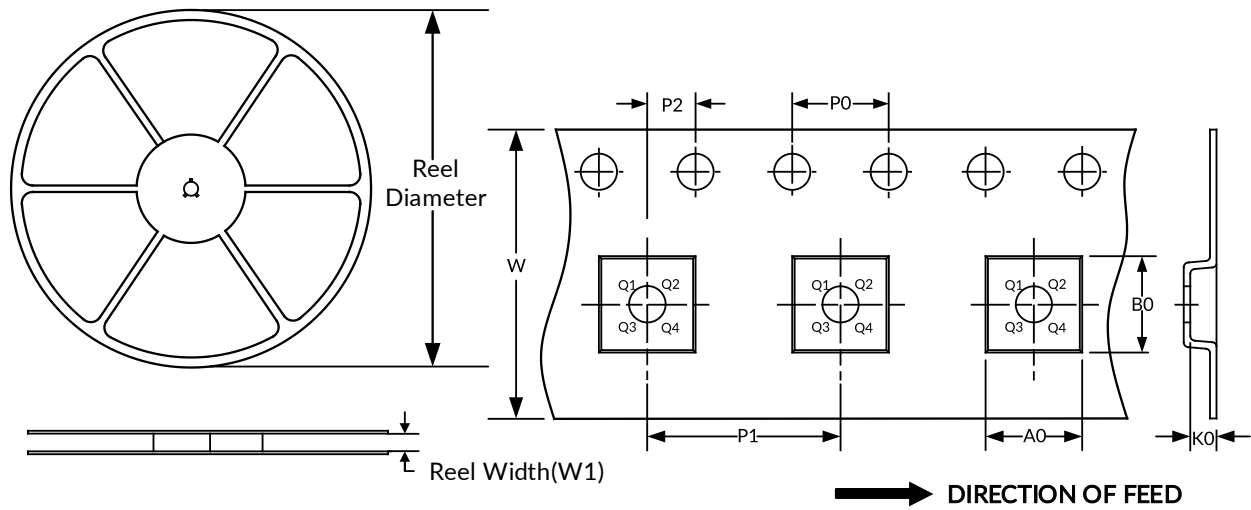

NOTE: The picture is only for reference. Please make the object as the standard.

KEY PARAMETER LIST OF TAPE AND REEL

Package Type	Reel Diameter	Reel Width (mm)	A0 (mm)	B0 (mm)	K0 (mm)	P0 (mm)	P1 (mm)	P2 (mm)	W (mm)	Pin1 Quadrant
SOP8	13"	12.4	6.40	5.40	2.10	4.0	8.0	2.0	12.0	Q1
MSOP8	13"	12.4	5.20	3.30	1.50	4.0	8.0	2.0	12.0	Q1
SOP14	13"	16.4	6.60	9.30	2.10	4.0	8.0	2.0	16.0	Q1

NOTE:

1. All dimensions are nominal.
2. Plastic or metal protrusions of 0.15mm maximum per side are not included.

IMPORTANT NOTICE AND DISCLAIMER

Jiangsu Runic Technology Co., Ltd. will accurately and reliably provide technical and reliability data (including data sheets), design resources (including reference designs), application or other design advice, WEB tools, safety information and other resources, without warranty of any defect, and will not make any express or implied warranty, including but not limited to the warranty of merchantability Implied warranty that it is suitable for a specific purpose or does not infringe the intellectual property rights of any third party.

These resources are intended for skilled developers designing with Runic products You will be solely responsible for: (1) Selecting the appropriate products for your application; (2) Designing, validating and testing your application; (3) Ensuring your application meets applicable standards and any other safety, security or other requirements; (4) Runic and the Runic logo are registered trademarks of Runic INCORPORATED. All trademarks are the property of their respective owners; (5) For change details, review the revision history included in any revised document. The resources are subject to change without notice. Our company will not be liable for the use of this product and the infringement of patents or third-party intellectual property rights due to its use.