

Low Power, Low Dropout, 200mA Linear Regulators

1 FEATURES

- **Low Dropout Voltage**
- **Thermal-Overload Protection**
- **Output Current Limit**
- **10nA Logic-Controlled Shutdown**
- **1μA Low Supply Current**
- **2.5V to 7.5V Input Voltage Range**
- **200mA Output Current**
- **-40°C to +85°C Operating Temperature Range**
- **Available in Green XDFN1X1-4, SOT23-5, SOT23-3, SC70-5 and SOT89-3(L-Type) Package**

2 APPLICATIONS

- **Cellular Telephones**
- **Camera Modules**
- **Modems**
- **HiFi Audio Radio Transceivers**
- **PLL/Synthesizer, Clocking**
- **Medium-Current, Noise-Sensitive Applications**

3 DESCRIPTIONS

The RS3221 series low-power, low-dropout, CMOS LDO operate from 2.5V to 7.5V input voltage that can supply up to 200 mA of output current. Designed to meet the requirements of analog circuits, the RS3221 series device provides low noise, high PSRR, low quiescent current, and low line and load transient response.

The device is designed to work with a 1-μF input and a 1-μF output ceramic capacitor (no separate noise bypass capacitor required). An external noise bypass capacitor connected to the device's BP pin can further reduce the noise level.

Other features include a 10nA logic-controlled shutdown mode, foldback current limit and thermal shutdown protection.

The RS3221 series is available in Green XDFN1X1-4, SOT23-3, SOT23-5, SC70-5 and SOT89-3(L-Type) package. It operates over an ambient temperature range of -40°C to +85°C.

Device Information⁽¹⁾

PART NUMBER	PACKAGE	BODY SIZE (NOM)
RS3221	XDFN1X1-4	1.00mm×1.00mm
	SOT23-3	1.60mm×2.92mm
	SOT23-5	1.60mm×2.92mm
	SC70-5	1.25mm×2.10mm
	SOT89-3	2.45mm×4.50mm

(1) For all available packages, see the orderable addendum at the end of the data sheet.

4 Functional Block Diagram

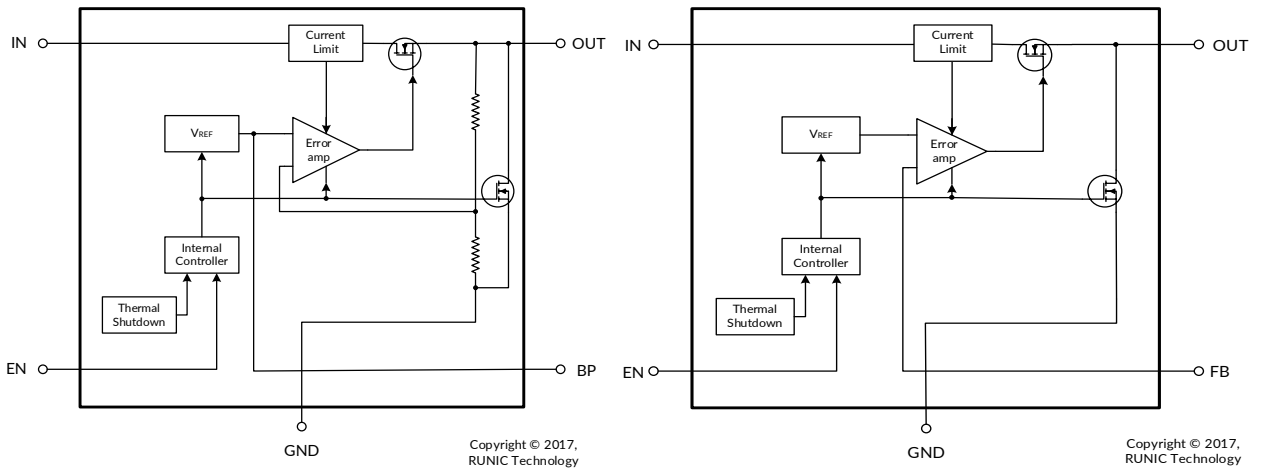

Table of Contents

1 FEATURES	1
2 APPLICATIONS	1
3 DESCRIPTIONS	1
4 Functional Block Diagram	2
5 Revision History	4
6 Pin Configuration and Functions (Top View)	5
7 PACKAGE/ORDERING INFORMATION	7
8 SPECIFICATIONS	10
8.1 Absolute Maximum Ratings	10
8.2 ESD Ratings	10
8.3 Recommended Operating Conditions	10
8.4 ELECTRICAL CHARACTERISTICS	11
8.5 TYPICAL APPLICATION CIRCUIT	13
8.6 TYPICAL PERFORMANCE CHARACTERISTICS	14
9 PACKAGE OUTLINE DIMENSIONS	16
10 TAPE AND REEL INFORMATION	21

5 Revision History

Note: Page numbers for previous revisions may differ from page numbers in the current version.

VERSION	Change Date	Change Item
A.1	2019/01/05	Initial version completed
A.2	2019/03/15	1. Added output voltage 2. Added SOT89-3 (L) package
A.3	2023/09/20	1. Update ELECTRICAL CHARACTERISTICS 2. Update Input Voltage 3. Added the TAPE AND REEL INFORMATION
A.3.1	2024/03/07	Modify packaging naming

6 Pin Configuration and Functions (Top View)

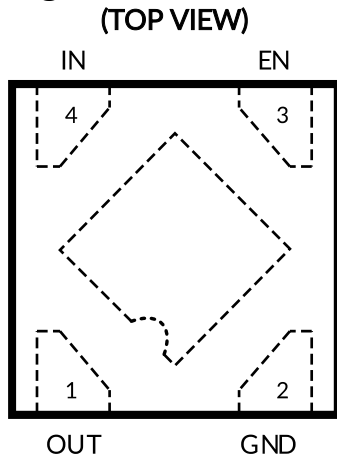
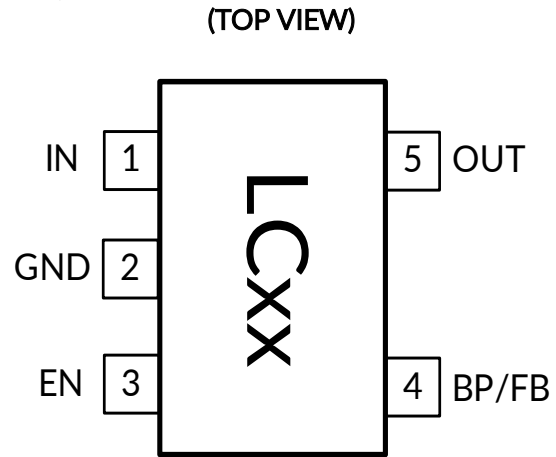
XDFN1X1-4

SOT23-5/SC70-5

XDFN1X1-4		I/O ⁽¹⁾	DESCRIPTION
NUMBER	NAME		
1	OUT	O	Regulator Output.
2	GND	G	Ground.
3	EN	I	Enable Input. A logic low reduces the supply current to 10nA. Connect to IN for normal operation.
4	IN	I	Regulator Input. Supply voltage can range from 2.5V to 7.5V. Bypass with a 1μF capacitor to GND.
Thermal Pad	-	-	Connect the thermal pad to a large-area ground plane. This pad is not an electrical connection to the device ground.

(1) I = Input, O = Output, G=Ground.

SOT23-5/SC70-5		I/O ⁽¹⁾	DESCRIPTION
NUMBER	NAME		
1	IN	I	Regulator Input. Supply voltage can range from 2.5V to 7.5V. Bypass with a 1μF capacitor to GND.
2	GND	G	Ground.
3	EN	I	Enable Input. A logic low reduces the supply current to 10nA. Connect to IN for normal operation.
4	BP	O	Reference-Noise Bypass (fixed voltage version only). Bypass with a low-leakage 0.01μF ceramic capacitor for reduced noise at the output. The capacitor is recommended to be placed very close to the pin for high PSRR.
	FB		Feedback Pin (adjustable voltage version only). This is used to set the output voltage of the device.
5	OUT	O	Regulator Output.

(1) I = Input, O = Output, G=Ground.

Pin Configuration and Functions (Top View)

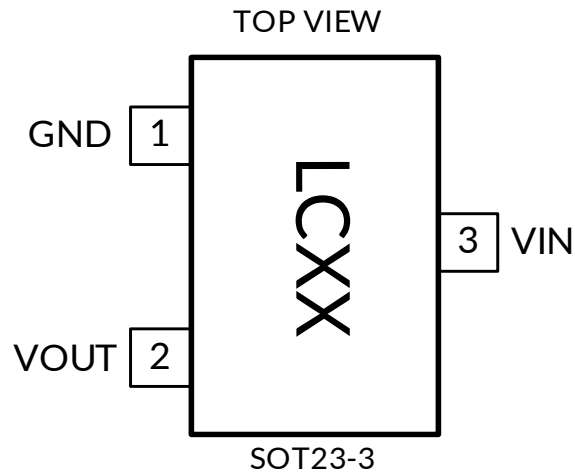

NOTE:XX indicate Output Voltage,xx indicate DataCode
For example:LC33(V_{OUT}=3.3V)

SOT23-3		I/O ⁽¹⁾	DESCRIPTION
NUMBER	NAME		
1	GND	G	Ground.
2	OUT	O	Regulator Output.
3	IN	I	Regulator Input. Supply voltage can range from 2.5V to 7.5V. Bypass with a 1μF capacitor to GND.

(1) I = Input, O = Output, G=Ground.

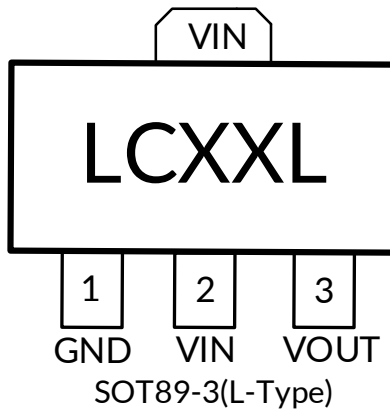

SOT89-3(L-Type)		I/O ⁽¹⁾	DESCRIPTION
NUMBER	NAME		
1	GND	G	Ground.
2	IN	I	Regulator Input. Supply voltage can range from 2.5V to 7.5V. Bypass with a 1μF capacitor to GND.
3	OUT	O	Regulator Output.

(1) I = Input, O = Output, G=Ground.

7 PACKAGE/ORDERING INFORMATION

PRODUCT	ORDERING NUMBER ⁽²⁾	V _{OUT} (V)	V _{OUT} Accuracy	PACKAGE LEAD	PACKAGE MARKING ⁽¹⁾	PACKAGE OPTION
RS3221-0.8	RS3221-0.8YUTDN4	0.8V	±2.5%	XDFN1X1-4	CA	Tape and Reel,10000
	RS3221-0.8YF5	0.8V	±2.5%	SOT23-5	LC08	Tape and Reel,3000
	RS3221-0.8YC5	0.8V	±2.5%	SC70-5 ⁽³⁾	LC08	Tape and Reel,3000
	RS3221-0.8YF3	0.8V	±2.5%	SOT23-3	LC08	Tape and Reel,3000
RS3221-1.0	RS3221-1.0YUTDN4	1.0V	±2.5%	XDFN1X1-4	CB	Tape and Reel,10000
	RS3221-1.0YF5	1.0V	±2.5%	SOT23-5	LC10	Tape and Reel,3000
	RS3221-1.0YC5	1.0V	±2.5%	SC70-5 ⁽³⁾	LC10	Tape and Reel,3000
	RS3221-1.0YF3	1.0V	±2.5%	SOT23-3	LC10	Tape and Reel,3000
RS3221-1.2	RS3221-1.2YUTDN4	1.2V	±2.5%	XDFN1X1-4	CC	Tape and Reel,10000
	RS3221-1.2YF5	1.2V	±2.5%	SOT23-5	LC12	Tape and Reel,3000
	RS3221-1.2YC5	1.2V	±2.5%	SC70-5 ⁽³⁾	LC12	Tape and Reel,3000
	RS3221-1.2YF3	1.2V	±2.5%	SOT23-3	LC12	Tape and Reel,3000
RS3221-1.35	RS3221-1.35YUTDN4	1.35V	±2.5%	XDFN1X1-4	CN	Tape and Reel,10000
RS3221-1.5	RS3221-1.5YUTDN4	1.5V	±2.5%	XDFN1X1-4	CD	Tape and Reel,10000
	RS3221-1.5YF5	1.5V	±2.5%	SOT23-5	LC15	Tape and Reel,3000
	RS3221-1.5YC5	1.5V	±2.5%	SC70-5 ⁽³⁾	LC15	Tape and Reel,3000
	RS3221-1.5YF3	1.5V	±2.5%	SOT23-3	LC15	Tape and Reel,3000
RS3221-1.8	RS3221-1.8YUTDN4	1.8V	±2.5%	XDFN1X1-4	CE	Tape and Reel,10000
	RS3221-1.8YF5	1.8V	±2.5%	SOT23-5	LC18	Tape and Reel,3000
	RS3221-1.8YC5	1.8V	±2.5%	SC70-5 ⁽³⁾	LC18	Tape and Reel,3000
	RS3221-1.8YF3	1.8V	±2.5%	SOT23-3	LC18	Tape and Reel,3000
	RS3221-1.8YE3L	1.8V	±2.5%	SOT89-3 (L-Type)	LC18L	Tape and Reel,1000
RS3221-1.85	RS3221-1.85YUTDN4	1.85V	±2.5%	XDFN1X1-4	CO	Tape and Reel,10000
RS3221-2.05	RS3221-2.05YUTDN4	2.05V	±2.5%	XDFN1X1-4	CF	Tape and Reel,10000
	RS3221-2.05YF5	2.05V	±2.5%	SOT23-5	LC205	Tape and Reel,3000
	RS3221-2.05YC5	2.05V	±2.5%	SC70-5 ⁽³⁾	LC205	Tape and Reel,3000
	RS3221-2.05YF3	2.05V	±2.5%	SOT23-3	LC205	Tape and Reel,3000
RS3221-2.5	RS3221-2.5YUTDN4	2.5V	±2.5%	XDFN1X1-4	CG	Tape and Reel,10000
	RS3221-2.5YF5	2.5V	±2.5%	SOT23-5	LC25	Tape and Reel,3000

	RS3221-2.5YC5	2.5V	±2.5%	SC70-5 ⁽³⁾	LC25	Tape and Reel,3000
	RS3221-2.5YF3	2.5V	±2.5%	SOT23-3	LC25	Tape and Reel,3000
	RS3221-2.5YE3L	2.5V	±2.5%	SOT89-3 (L-Type)	LC25L	Tape and Reel,1000
RS3221-2.8	RS3221-2.8YUTDN4	2.8V	±2.5%	XDFN1X1-4	CH	Tape and Reel,10000
	RS3221-2.8YF5	2.8V	±2.5%	SOT23-5	LC28	Tape and Reel,3000
	RS3221-2.8YC5	2.8V	±2.5%	SC70-5 ⁽³⁾	LC28	Tape and Reel,3000
	RS3221-2.8YF3	2.8V	±2.5%	SOT23-3	LC28	Tape and Reel,3000
RS3221-3.0	RS3221-3.0YUTDN4	3.0V	±2.5%	XDFN1X1-4	CI	Tape and Reel,10000
	RS3221-3.0YF5	3.0V	±2.5%	SOT23-5	LC30	Tape and Reel,3000
	RS3221-3.0YC5	3.0V	±2.5%	SC70-5 ⁽³⁾	LC30	Tape and Reel,3000
	RS3221-3.0YF3	3.0V	±2.5%	SOT23-3	LC30	Tape and Reel,3000
RS3221-3.3	RS3221-3.3YUTDN4	3.3V	±2.5%	XDFN1X1-4	CJ	Tape and Reel,10000
	RS3221-3.3YF5	3.3V	±2.5%	SOT23-5	LC33	Tape and Reel,3000
	RS3221-3.3YC5	3.3V	±2.5%	SC70-5 ⁽³⁾	LC33	Tape and Reel,3000
	RS3221-3.3YF3	3.3V	±2.5%	SOT23-3	LC33	Tape and Reel,3000
	RS3221-3.3YE3L	3.3V	±2.5%	SOT89-3 (L-Type)	LC33L	Tape and Reel,1000
RS3221-3.6	RS3221-3.6YUTDN4	3.6V	±2.5%	XDFN1X1-4	CK	Tape and Reel,10000
	RS3221-3.6YF5	3.6V	±2.5%	SOT23-5	LC36	Tape and Reel,3000
	RS3221-3.6YC5	3.6V	±2.5%	SC70-5 ⁽³⁾	LC36	Tape and Reel,3000
	RS3221-3.6YF3	3.6V	±2.5%	SOT23-3	LC36	Tape and Reel,3000
RS3221-4.0	RS3221-4.0YUTDN4	4.0V	±2.5%	XDFN1X1-4	CL	Tape and Reel,10000
	RS3221-4.0YF5	4.0V	±2.5%	SOT23-5	LC40	Tape and Reel,3000
	RS3221-4.0YC5	4.0V	±2.5%	SC70-5 ⁽³⁾	LC40	Tape and Reel,3000
	RS3221-4.0YF3	4.0V	±2.5%	SOT23-3	LC40	Tape and Reel,3000
RS3221-5.0	RS3221-5.0YUTDN4	5.0V	±2.5%	XDFN1X1-4	CM	Tape and Reel,10000
	RS3221-5.0YF5	5.0V	±2.5%	SOT23-5	LC50	Tape and Reel,3000
	RS3221-5.0YC5	5.0V	±2.5%	SC70-5 ⁽³⁾	LC50	Tape and Reel,3000
	RS3221-5.0YF3	5.0V	±2.5%	SOT23-3	LC50	Tape and Reel,3000
RS3221-2.7	RS3221-2.7YF5	2.7V	±2.5%	SOT23-5	LC27	Tape and Reel,3000
RS3221-2.85	RS3221-2.85YF5	2.85V	±2.5%	SOT23-5	LC285	Tape and Reel,3000

PRODUCT	ORDERING NUMBER ⁽²⁾	V _{OUT} (V)	V _{OUT} Accuracy	PACKAGE LEAD	PACKAGE MARKING ⁽¹⁾	PACKAGE OPTION
RS3221-3.3	RS3221-3.3AYUTDN4	3.3V	±1%	XDFN1X1-4	CJ	Tape and Reel,10000

MODEL	V _{FB} (V)	PIN-PACKAGE	ORDERING NUMBER	PACKAGE MARKING ⁽¹⁾	PACKAGE OPTION
RS3221-ADJ8	0.81	SOT23-5	RS3221-ADJ8YF5	LCAD8	Tape and Reel, 3000
		SC70-5 ⁽³⁾	RS3221-ADJ8YC5	LCAD8	Tape and Reel, 3000
RS3221-ADJ1	1.21	SOT23-5	RS3221-ADJ1YF5	LCAD8	Tape and Reel, 3000
		SC70-5 ⁽³⁾	RS3221-ADJ1YC5	LCAD8	Tape and Reel, 3000

NOTE:

(1) There may be additional marking, which relates to the lot trace code information(data code and vendor code), the logo or the environmental category on the device.

(2) RS3221-□□□□

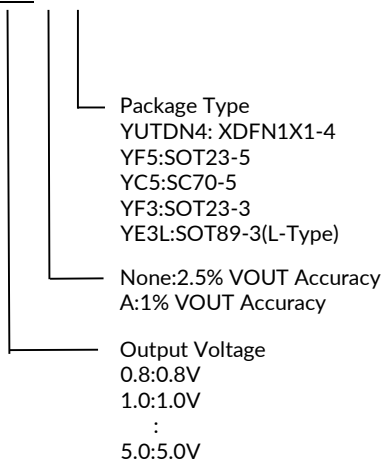

(3) Equivalent to SOT353.

8 SPECIFICATIONS

8.1 Absolute Maximum Ratings

over operating free-air temperature range (unless otherwise noted) ⁽¹⁾⁽²⁾

		MIN	MAX	UNIT	
V _{IN}	Input voltage	-0.3	8	V	
V _{EN}	Enable input voltage	-0.3	V _{IN}	V	
θ _{JA}	Package thermal impedance ⁽³⁾	SOT23-5		230	°C/W
		SOT23-3		295	
		XDFN1X1-4		315	
		SC70-5		380	
		SOT89-3 (L-Type)		210	
T _J	Junction temperature ⁽⁴⁾		150	°C	
P _D	Continuous power dissipation ⁽⁵⁾	Internally Limited		W	
T _{stg}	Storage temperature	-65	150	°C	

- Stresses beyond those listed under Absolute Maximum Ratings may cause permanent damage to the device. These are stress ratings only, and functional operation of the device at these or any other conditions beyond those indicated under Recommended Operating Conditions is not implied. Exposure to absolute-maximum-rated conditions for extended periods may affect device reliability.
- All voltages are with respect to the GND pin.
- The package thermal impedance is calculated in accordance with JESD-51.
- The maximum power dissipation is a function of T_{J(MAX)}, R_{θJA}, and T_A. The maximum allowable power dissipation at any ambient temperature is P_D = (T_{J(MAX)} - T_A) / R_{θJA}. All numbers apply for packages soldered directly onto a PCB.
- Internal thermal shutdown circuitry protects the device from permanent damage.

8.2 ESD Ratings

The following ESD information is provided for handling of ESD-sensitive devices in an ESD protected area only.

		VALUE	UNIT	
V _(ESD)	Electrostatic discharge	Human-body model (HBM)	±6000	V
		Machine model (MM)	±400	V



ESD SENSITIVITY CAUTION

ESD damage can range from subtle performance degradation to complete device failure. Precision integrated circuits may be more susceptible to damage because very small parametric changes could cause the device not to meet its published specifications.

8.3 Recommended Operating Conditions

over operating free-air temperature range (unless otherwise noted) ⁽¹⁾

		MIN	MAX	UNIT
V _{IN}	Input supply voltage	2.5	7.5	V
V _{EN}	Enable input voltage	0	V _{IN}	V
I _{OUT}	Output current	0	200	mA
T _A	Operating temperature	-40	+85	°C

- All voltages are with respect to the GND pin.

8.4 ELECTRICAL CHARACTERISTICS

($V_{IN} = V_{OUT(NOMINAL)} + 0.5V^{(1)}$, Full = -40°C to +85°C, unless otherwise noted.)

PARAMETER	SYMBOL	CONDITIONS	TEMP	MIN	TYP	MAX	UNITS
Input Voltage	V_{IN}		+25°C	2.5 ⁽¹⁾		7.5	V
Output Voltage Accuracy		$I_{OUT} = 0.1mA$	+25°C	-2.5		2.5	%
		$I_{OUT} = 0.1mA$, RS3221-x.xA	+25°C	-1		1	%
Feedback Voltage	V_{FB}	$I_{OUT} = 0.1 mA$, RS3221-ADJ8	+25°C	0.79	0.81	0.83	V
		$I_{OUT} = 0.1 mA$, RS3221-ADJC	+25°C	1.18	1.21	1.24	V
Maximum Output Current			+25°C	200			mA
Current Limit	I_{LIM}		+25°C		300		mA
Ground Pin Current	I_Q	No load	+25°C		1.0		μA
Dropout Voltage ⁽²⁾	V_{DROP}	$I_{OUT} = 200mA$	+25°C	V _{OUT} =1.2V		580	mV
				V _{OUT} =1.5V		400	
				V _{OUT} =1.8V		280	
				V _{OUT} =3.0V		160	
				V _{OUT} =3.3V		155	
Line Regulation	ΔV_{LNR}	$V_{IN} = (V_{OUT} + 0.5V)$ to 7.5V, $I_{OUT} = 1mA$	+25°C		0.1	0.2	%/V
Load Regulation	ΔV_{OUT}	$I_{OUT} = 0.1mA$ to 200mA, $C_{OUT} = 1\mu F$	+25°C		15	30	mV
		$I_{OUT} = 0.1mA$ to 200mA, $C_{OUT} = 1\mu F$, RS3221-ADJ	+25°C		0.5	10	mV
Output Voltage Noise	e_n	$f = 10Hz$ to 100kHz, $C_{BP} = 10nF$, $C_{OUT} = 1\mu F$, $I_{OUT} = 30mA$	+25°C		170		μV _{RMS}
Output Voltage Temperature Coefficient	$\frac{\Delta V_{OUT}}{\Delta T_A \times V_{OUT}}$	$I_{LOAD} = 0.1mA$	FULL		65		ppm/°C
Power Supply Rejection Ratio	PSRR	$C_{BP} = 0\mu F$, $I_{LOAD} = 30mA$, $C_{OUT} = 1\mu F$, $V_{IN} = V_{OUT} + 1V$ $\Delta V_{RIPPLE} = 0.2V_{P-P}$	$f = 217Hz$	+25°C		46	dB
			$f = 1kHz$			34	
		$C_{BP} = 10nF$, $I_{LOAD} = 30mA$, $C_{OUT} = 1\mu F$, $V_{IN} = V_{OUT} + 1V$ $\Delta V_{RIPPLE} = 0.2V_{P-P}$	$f = 217Hz$	+25°C		48	dB
			$f = 1kHz$			36	
SHUTDOWN							
EN Input Threshold	V_{IH}	$V_{IN} = 2.5V$	Full	1.4			V
	V_{IL}		Full			0.4	
EN Input Threshold	V_{IH}	$V_{IN} = 7.5V$	Full	2.3			V
	V_{IL}		Full			0.8	
EN Input Bias Current	I_{BH}	EN = 7.5V	+25°C		0.01	1	μA
	I_{BL}	EN = 0V	Full		0.01		
Shutdown Supply Current	$I_{Q(SHDN)}$	EN = 0V	Full		0.01	1	μA
Start-Up Time ⁽³⁾	t_{STR}	$C_{OUT} = 1\mu F$, No Load	+25°C		180		μs

RON of Discharge MOSFET		$V_{IN} = 4.0V, V_{EN} = 0V$	+25°C		25		Ω
THERMAL PROTECTION							
Thermal Shutdown Temperature	T_{SHDN}				140		°C

NOTES:

1. $V_{IN} = V_{OUT(NOMINAL)} + 0.5V$ or $2.5V$, whichever is greater.
2. The dropout voltage is defined as $V_{IN} - V_{OUT}$, when V_{OUT} is 100mV below the value of V_{OUT} for $V_{IN} = V_{OUT} + 0.5V$.
3. Time needed for V_{OUT} to reach 90% of final value.

8.5 TYPICAL APPLICATION CIRCUIT

<p style="text-align: center;">Typical Circuit</p> <p style="text-align: center;">SOT23-5/SOT353(SC70-5)</p>	<p style="text-align: center;">Typical Circuit</p> <p style="text-align: center;">SOT23-5/SOT353(SC70-5)</p>
<p style="text-align: center;">Typical Circuit</p> <p style="text-align: center;">SOT23-5/SOT353(SC70-5)</p>	<p style="text-align: center;">Typical Circuit</p> <p style="text-align: center;">SOT23-5/SOT353(SC70-5)</p>
<p>NOTE: Choose $R_2 = 160k\Omega$ to maintain a $5\mu A$ minimum load. Calculate the value for R_1 using the following equation:</p> $R_1 = R_2 * \left(\frac{V_{OUT}}{0.81} - 1 \right)$	<p>NOTE: Choose $R_2 = 240k\Omega$ to maintain a $5\mu A$ minimum load. Calculate the value for R_1 using the following equation:</p> $R_1 = R_2 * \left(\frac{V_{OUT}}{1.21} - 1 \right)$
<p style="text-align: center;">Typical Circuit</p> <p style="text-align: center;">UTDFN-1x1-4</p>	

8.6 TYPICAL PERFORMANCE CHARACTERISTICS

NOTE: The graphs and tables provided following this note are a statistical summary based on a limited number of samples and are provided for informational purposes only.

$V_{IN} = V_{OUT (NOMINAL)} + 0.5V$, $C_{IN} = 1\mu F$, $C_{OUT} = 1\mu F$, $C_{BP} = 0\mu F$, $T_A = +25^\circ C$, unless otherwise noted.

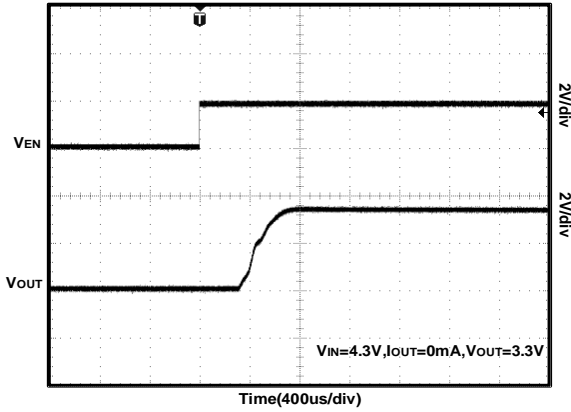

Figure 1. Turn on Speed with EN Pin

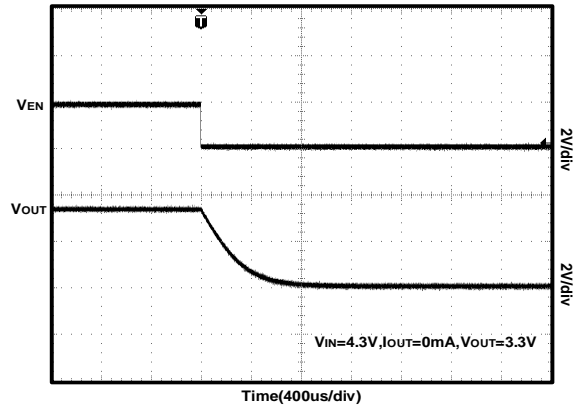

Figure 2. Turn Off Speed with EN Pin

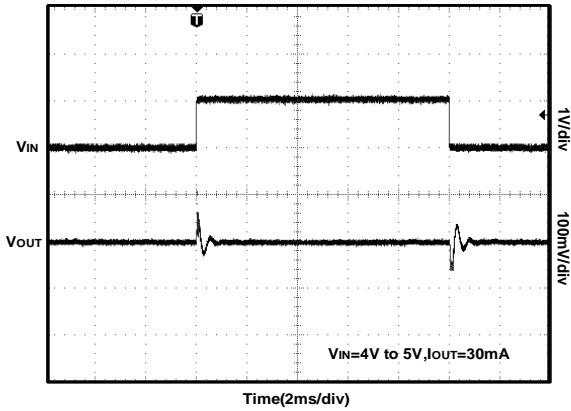

Figure 3. Line Transient Response

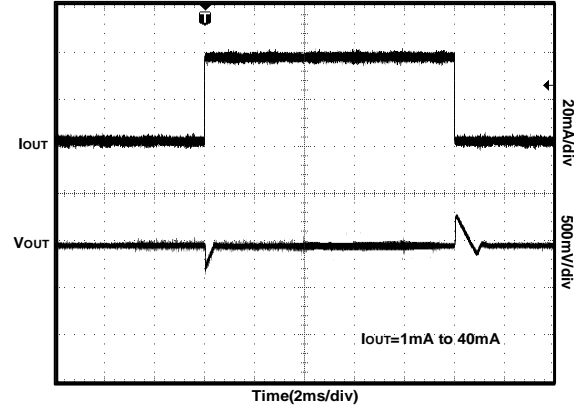

Figure 4. Load Transient Response

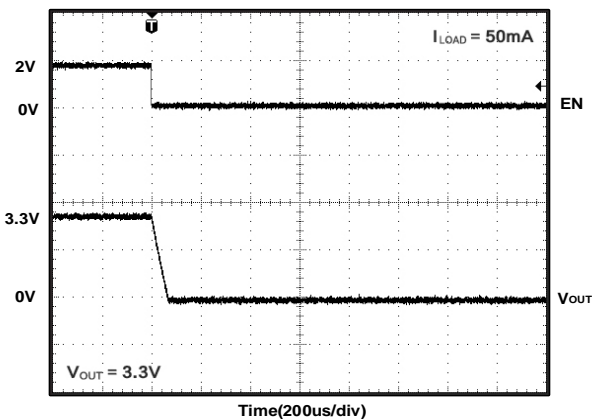

Figure 5. SHUTDOWN

TYPICAL PERFORMANCE CHARACTERISTICS

NOTE: The graphs and tables provided following this note are a statistical summary based on a limited number of samples and are provided for informational purposes only.

$V_{IN} = V_{OUT (NOMINAL)} + 0.5V$, $C_{IN} = 1\mu F$, $C_{OUT} = 1\mu F$, $C_{BP} = 0\mu F$, $T_A = +25^\circ C$, unless otherwise noted.

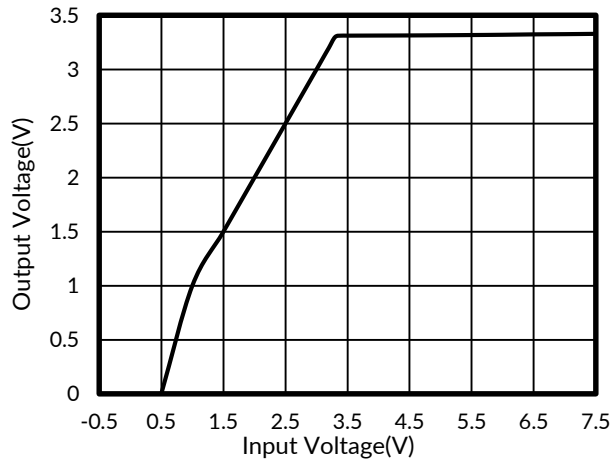

Figure 6. Output Voltage vs Input Voltage



Figure 7. Supply pin Current vs Input Voltage

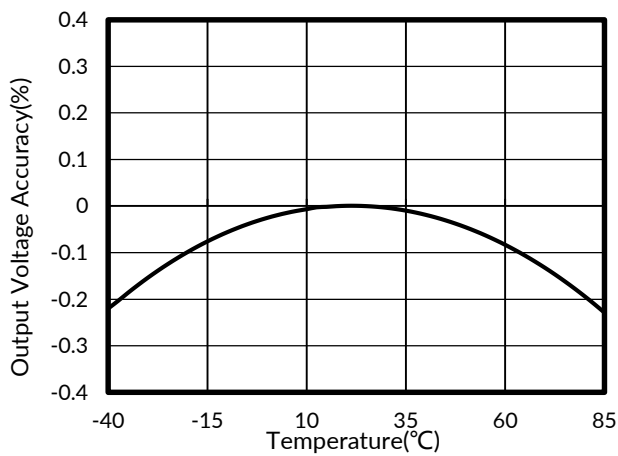

Figure 8. Output Voltage Accuracy vs Temperature

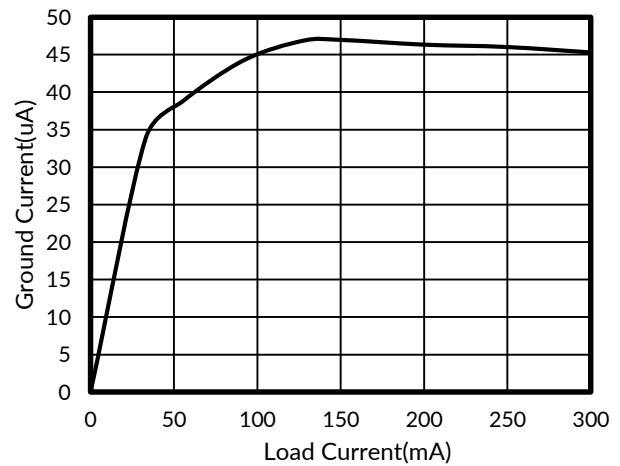

Figure 9. Ground Current vs Load Current

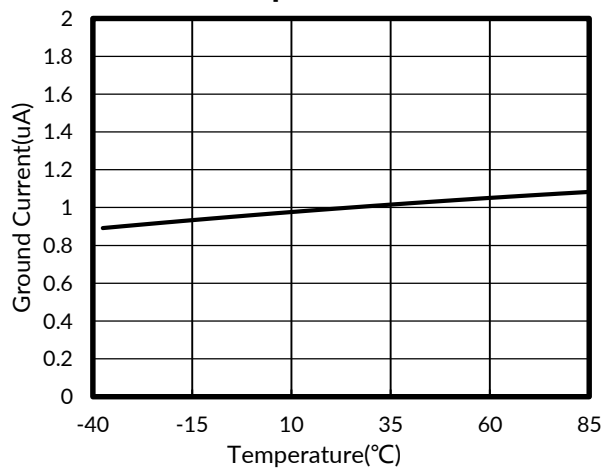
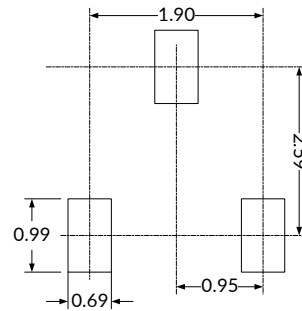
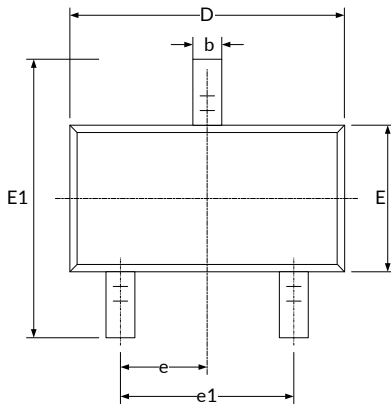

Figure 10. Ground Current vs Temperature

9 PACKAGE OUTLINE DIMENSIONS

SOT23-3⁽³⁾



RECOMMENDED LAND PATTERN (Unit: mm)

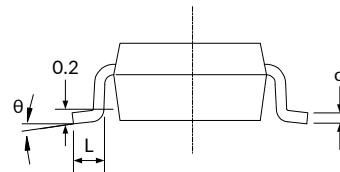
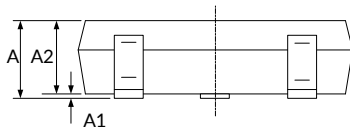

Symbol	Dimensions In Millimeters		Dimensions In Inches	
	Min	Max	Min	Max
A ⁽¹⁾	1.050	1.250	0.041	0.049
A1	0.000	0.100	0.000	0.004
A2	1.050	1.150	0.041	0.045
b	0.300	0.500	0.012	0.020
c	0.100	0.200	0.004	0.008
D ⁽¹⁾	2.820	3.020	0.111	0.119
E ⁽¹⁾	1.500	1.700	0.059	0.067
E1	2.650	2.950	0.104	0.116
e	0.950(BSC) ⁽²⁾		0.037(BSC) ⁽²⁾	
e1	1.800	2.000	0.071	0.079
L	0.300	0.600	0.012	0.024
θ	0°	8°	0°	8°

NOTE:

1. Plastic or metal protrusions of 0.15mm maximum per side are not included.
2. BSC (Basic Spacing between Centers), "Basic" spacing is nominal.
3. This drawing is subject to change without notice.

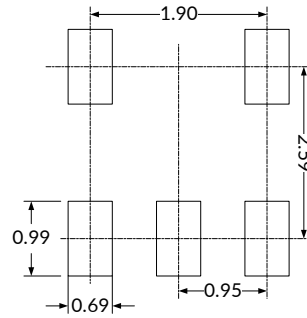
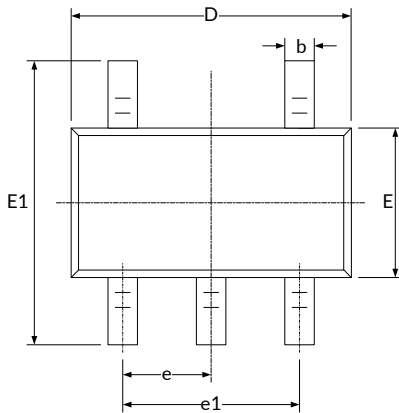
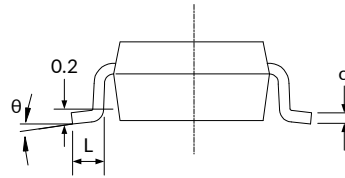
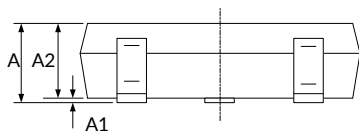
SOT23-5⁽³⁾

RECOMMENDED LAND PATTERN (Unit: mm)

Symbol	Dimensions In Millimeters		Dimensions In Inches	
	Min	Max	Min	Max
A ⁽¹⁾	1.050	1.250	0.041	0.049
A1	0.000	0.100	0.000	0.004
A2	1.050	1.150	0.041	0.045
b	0.300	0.500	0.012	0.020
c	0.100	0.200	0.004	0.008
D ⁽¹⁾	2.820	3.020	0.111	0.119
E ⁽¹⁾	1.500	1.700	0.059	0.067
E1	2.650	2.950	0.104	0.116
e	0.950(BSC) ⁽²⁾		0.037(BSC) ⁽²⁾	
e1	1.800	2.000	0.071	0.079
L	0.300	0.600	0.012	0.024
θ	0°	8°	0°	8°

NOTE:

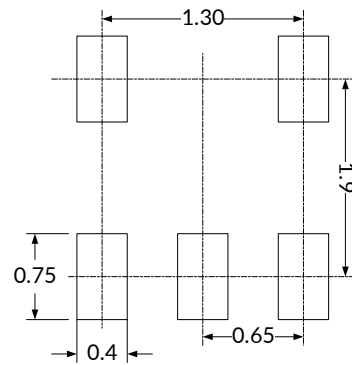
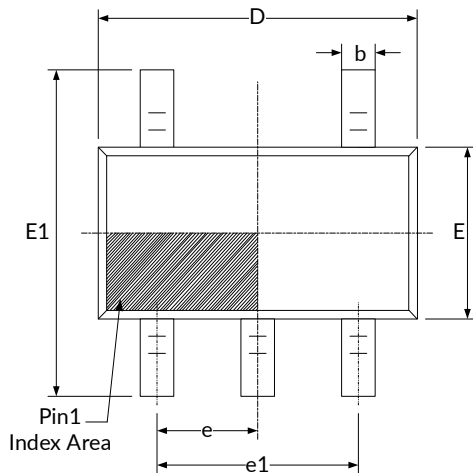
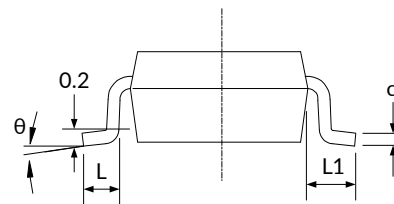
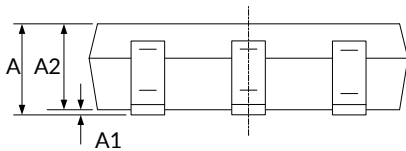
1. Plastic or metal protrusions of 0.15mm maximum per side are not included.
2. BSC (Basic Spacing between Centers), "Basic" spacing is nominal.
3. This drawing is subject to change without notice.

SC70-5⁽³⁾

RECOMMENDED LAND PATTERN (Unit: mm)

Symbol	Dimensions In Millimeters		Dimensions In Inches	
	Min	Max	Min	Max
A ⁽¹⁾	0.900	1.100	0.035	0.043
A1	0.000	0.100	0.000	0.004
A2	0.900	1.000	0.035	0.039
b	0.150	0.350	0.006	0.014
c	0.080	0.150	0.003	0.006
D ⁽¹⁾	2.000	2.200	0.079	0.087
E ⁽¹⁾	1.150	1.350	0.045	0.053
E1	2.150	2.450	0.085	0.096
e	0.650(BSC) ⁽²⁾		0.026(BSC) ⁽²⁾	
e1	1.300(BSC) ⁽²⁾		0.051(BSC) ⁽²⁾	
L	0.260	0.460	0.010	0.018
L1	0.525		0.021	
θ	0°	8°	0°	8°

NOTE:

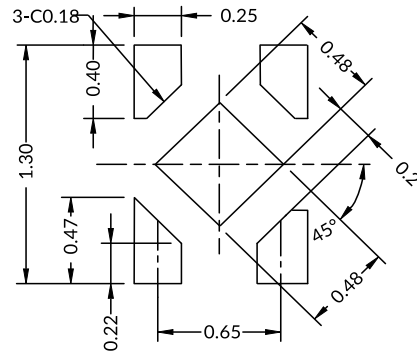
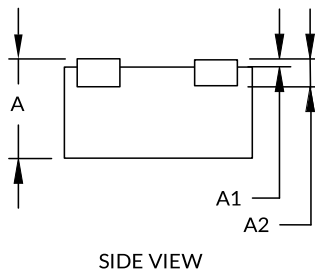
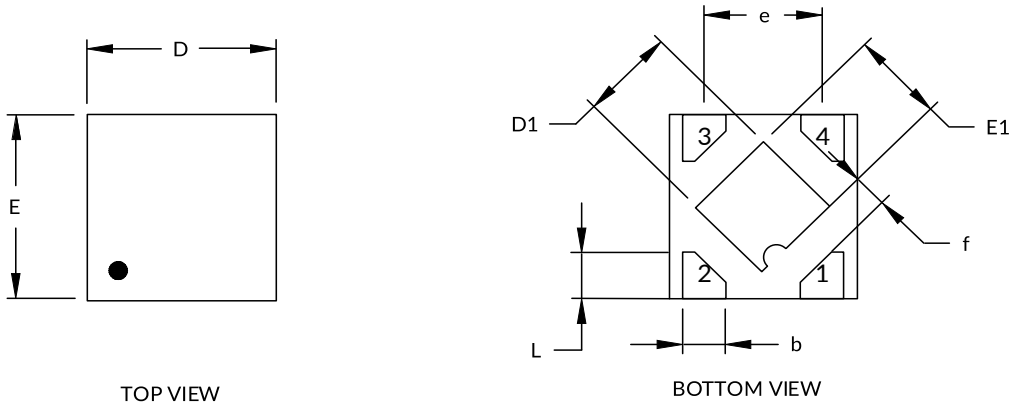
1. Plastic or metal protrusions of 0.15mm maximum per side are not included.
2. BSC (Basic Spacing between Centers), "Basic" spacing is nominal.
3. This drawing is subject to change without notice.

XDFN1X1-4⁽³⁾

RECOMMENDED LAND PATTERN (Unit: mm)

Symbol	Dimensions In Millimeters			Dimensions In Inches		
	MIN	TYP	MAX	MIN	TYP	MAX
A ⁽¹⁾	0.340	0.370	0.400	0.013	0.015	0.016
A1	0.000	0.020	0.050	0.000	0.001	0.002
A2	0.100 REF ⁽²⁾			0.004 REF ⁽²⁾		
D ⁽¹⁾	0.950	1.000	1.050	0.037	0.039	0.041
D1	0.430	0.480	0.530	0.017	0.019	0.021
E ⁽¹⁾	0.950	1.000	1.050	0.037	0.039	0.041
E1	0.430	0.480	0.530	0.017	0.019	0.021
b	0.170	0.220	0.270	0.007	0.009	0.011
e	0.600	0.650	0.700	0.024	0.026	0.028
f	0.195 REF ⁽²⁾			0.008 REF ⁽²⁾		
L	0.200	0.250	0.300	0.008	0.010	0.012

NOTE:

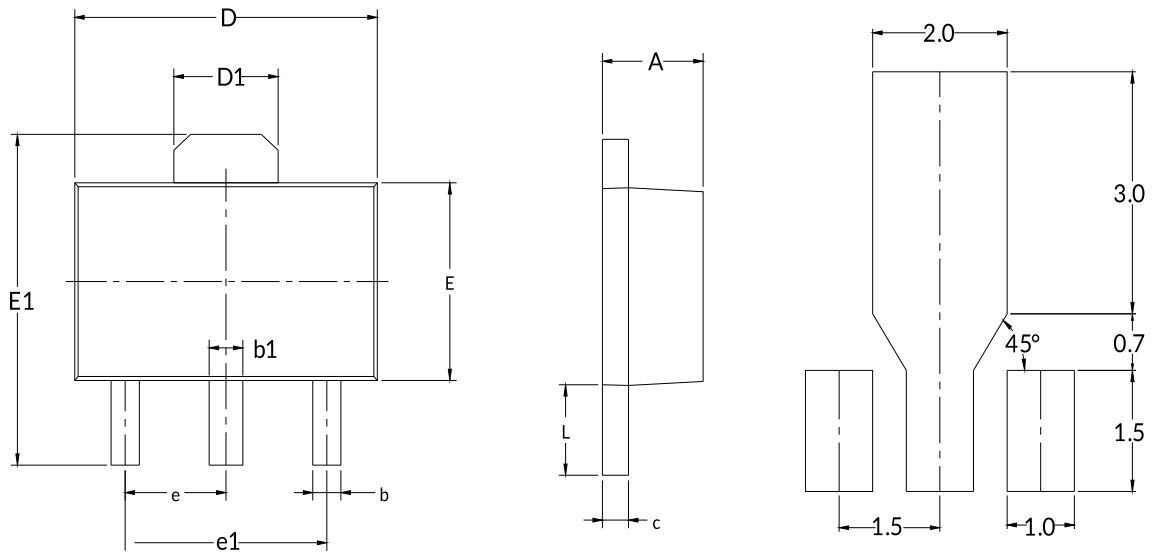
1. Plastic or metal protrusions of 0.075mm maximum per side are not included.
2. REF is the abbreviation for Reference.
3. This drawing is subject to change without notice.

SOT89-3⁽⁴⁾

RECOMMENDED LAND PATTERN (Unit: mm)

Symbol	Dimensions In Millimeters		Dimensions In Inches	
	Min	Max	Min	Max
A ⁽¹⁾	1.400	1.600	0.055	0.063
b	0.320	0.520	0.013	0.020
b1	0.400	0.580	0.016	0.023
c	0.350	0.440	0.014	0.017
D ⁽¹⁾	4.400	4.600	0.173	0.181
D1	1.550 REF ⁽²⁾		0.061 REF ⁽²⁾	
E ⁽¹⁾	2.300	2.600	0.091	0.102
E1	3.940	4.250	0.155	0.167
e	1.500 BSC ⁽³⁾		0.060 BSC ⁽³⁾	
e1	3.000 BSC ⁽³⁾		0.118 BSC ⁽³⁾	
L	0.900	1.200	0.035	0.047

NOTE:

1. Plastic or metal protrusions of 0.15mm maximum per side are not included.
2. REF is the abbreviation for Reference.
3. BSC (Basic Spacing between Centers), "Basic" spacing is nominal.
4. This drawing is subject to change without notice.

10 TAPE AND REEL INFORMATION

REEL DIMENSIONS

TAPE DIMENSION

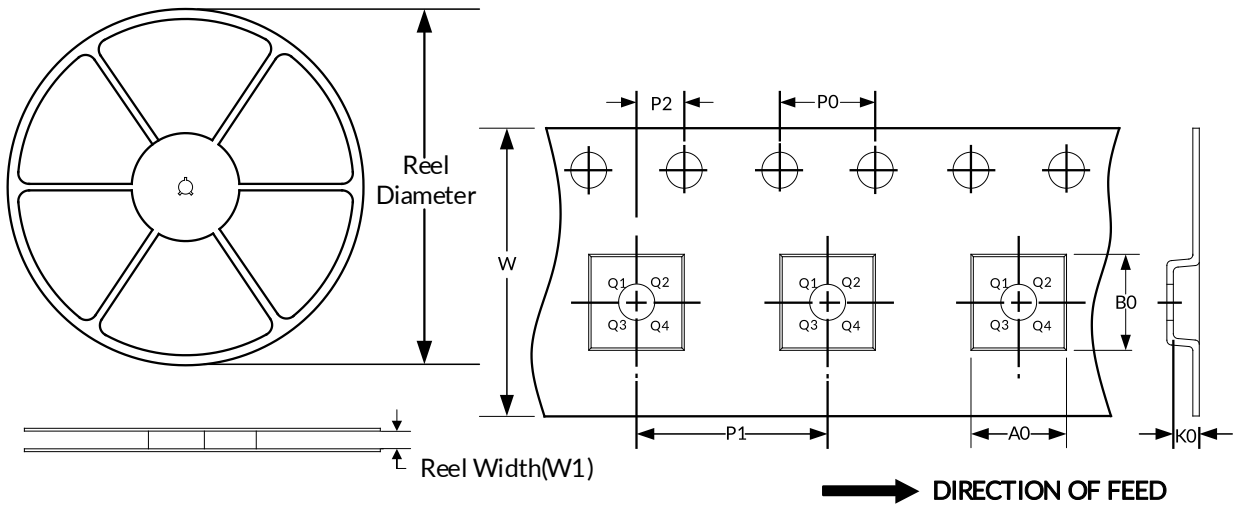

NOTE: The picture is only for reference. Please make the object as the standard.

KEY PARAMETER LIST OF TAPE AND REEL

Package Type	Reel Diameter	Reel Width(mm)	A0 (mm)	B0 (mm)	K0 (mm)	P0 (mm)	P1 (mm)	P2 (mm)	W (mm)	Pin1 Quadrant
XDFN1X1-4	7"	9.5	1.16	1.16	0.5	4.0	4.0	2.0	8.0	Q1
SOT23-3	7"	9.0	3.20	3.30	1.30	4.0	4.0	2.0	8.0	Q3
SOT23-5	7"	9.5	3.20	3.20	1.40	4.0	4.0	2.0	8.0	Q3
SC70-5	7"	9.5	2.25	2.55	1.20	4.0	4.0	2.0	8.0	Q3
SOT89-3	7"	13.2	4.85	4.45	1.85	4.0	8.0	2.0	12.0	Q3

NOTE:

1. All dimensions are nominal.
2. Plastic or metal protrusions of 0.15mm maximum per side are not included.

IMPORTANT NOTICE AND DISCLAIMER

Jiangsu Runic Technology Co., Ltd. will accurately and reliably provide technical and reliability data (including data sheets), design resources (including reference designs), application or other design advice, WEB tools, safety information and other resources, without warranty of any defect, and will not make any express or implied warranty, including but not limited to the warranty of merchantability Implied warranty that it is suitable for a specific purpose or does not infringe the intellectual property rights of any third party.

These resources are intended for skilled developers designing with Runic products You will be solely responsible for: (1) Selecting the appropriate products for your application; (2) Designing, validating and testing your application; (3) Ensuring your application meets applicable standards and any other safety, security or other requirements; (4) Runic and the Runic logo are registered trademarks of Runic Incorporated. All trademarks are the property of their respective owners; (5) For change details, review the revision history included in any revised document. The resources are subject to change without notice. Our company will not be liable for the use of this product and the infringement of patents or third-party intellectual property rights due to its use.