

General-Purpose High-Voltage Open-Drain Output Single Comparator

1 FEATURES

- **Supply Range: +3V to +32V**
- **Low Supply Current**
65µA (TYP) per channel at $V_s = 5V$
- **Low Output Saturation Voltage**
- **Open-Drain Output for Maximum Flexibility**
- **SPECIFIED UP TO +125°C**
- **Micro SIZE PACKAGES: SOT23-5**

2 APPLICATIONS

- **Hysteresis Comparators**
- **Factory Automation & Control**
- **Industrial Equipment**
- **Test and Measurement**
- **Cordless Power Tool**
- **Vacuum Robot**
- **Wireless Infrastructure**

3 DESCRIPTIONS

The LM331 is the single comparator version, and the outputs can be connected to other open-collector outputs to achieve wired-AND relationships. It can operate from 3V to 32V, and have low power consuming 65µA (TYP) per channel.

The LM331 consist one voltage comparators that are designed to operate from a single power supply over a wide range of voltages. Quiescent current is independent of the supply voltage. The device is the most cost-effective solutions for applications where low offset voltage, high supply voltage capability, low supply current, and space saving are the primary specifications in circuit design for portable consumer products.

The LM331 is available in Green SOT23-5 packages. It operates over an ambient temperature range of -40°C to +125°C.

Device Information ⁽¹⁾

PART NUMBER	PACKAGE	BODY SIZE (NOM)
LM331	SOT23-5	2.90mm×1.60mm

(1) For all available packages, see the orderable addendum at the end of the data sheet.

Table of Contents

1 FEATURES	1
2 APPLICATIONS	1
3 DESCRIPTIONS	1
4 Revision History	3
5 PACKAGE/ORDERING INFORMATION ⁽¹⁾	4
6 Pin Configuration and Functions (Top View)	5
7 SPECIFICATIONS	6
7.1 Absolute Maximum Ratings	6
7.2 ESD Ratings	6
7.3 Recommended Operating Conditions	6
7.4 ELECTRICAL CHARACTERISTICS	7
7.5 TYPICAL CHARACTERISTICS	8
8 Detailed Description	9
8.1 Overview	9
9 Application and Implementation	10
9.1 Application Information	10
9.2 Typical Application	10
9.3 Detailed Design Procedure	10
9.4 Input Voltage Range	10
10 PACKAGE OUTLINE DIMENSIONS	11
11 TAPE AND REEL INFORMATION	12

4 Revision History

Note: Page numbers for previous revisions may differ from page numbers in the current version.

VERSION	Change Date	Change Item
A.0	2020/02/11	Pre version completed
A.1	2022/02/23	1. Modify ELECTRICAL CHARACTERISTICS and TYPICAL CHARACTERISTICS 2. Add TAPE AND REEL INFORMATION
A.2	2022/07/15	Change Supply Range: +3V to +32V
A.2.1	2024/02/23	Modify packaging naming
A.3	2024/03/27	1. Added MSL on Page 4@RevA.2.1 2. Update Package thermal impedance 3. Update PACKAGE note

5 PACKAGE/ORDERING INFORMATION ⁽¹⁾

Orderable Device	Package Type	Pin	Channel	Op Temp(°C)	Device Marking ⁽²⁾	MSL ⁽³⁾	Package Qty
LM331BXF	SOT23-5	5	1	-40°C ~+125°C	331B	MSL3	Tape and Reel, 3000
LM331CXF	SOT23-5	5	1	-40°C ~+125°C	331C	MSL3	Tape and Reel, 3000

NOTE:

- (1) This information is the most current data available for the designated devices. This data is subject to change without notice and revision of this document. For browser-based versions of this data sheet, refer to the right-hand navigation.
- (2) There may be additional marking, which relates to the lot trace code information (data code and vendor code), the logo or the environmental category on the device.
- (3) MSL, The Moisture Sensitivity Level rating according to the JEDEC industry standard classifications.

6 Pin Configuration and Functions (Top View)

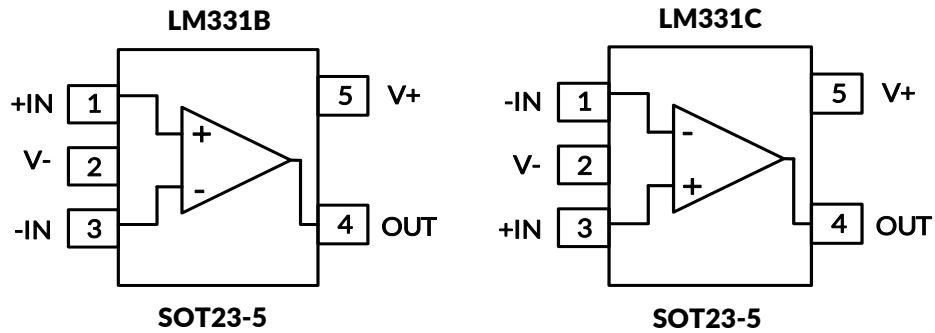

Pin Description

NAME	PIN SOT23-5		I/O ⁽¹⁾	DESCRIPTION
	LM331B	LM331C		
+IN	1	3	I	Noninverting input
V-	2	2	P	Negative (lowest) power supply
-IN	3	1	I	Inverting input
OUT	4	4	O	Output
V+	5	5	P	Positive (highest) power supply

(1) I=Input, O=Output, P=Power.

7 SPECIFICATIONS

7.1 Absolute Maximum Ratings

Over operating free-air temperature range (unless otherwise noted) ⁽¹⁾

		MIN	MAX	UNIT
Voltage	Supply, $V_S=(V+) - (V-)$		36	V
	Input pin (IN+, IN-) ⁽²⁾	(V-)-0.3	(V+) +0.3	
	Signal output pin ⁽³⁾	(V-)-0.3	(V+) +0.3	
Current	Signal input pin (IN+, IN-) ⁽²⁾	-10	10	mA
	Signal output pin ⁽³⁾	-55	55	mA
	Output short-circuit ⁽⁴⁾	Continuous		
θ_{JA}	Package thermal impedance ⁽⁵⁾	SOT23-5	230	°C/W
Temperature	Operating range, T_A	-40	125	°C
	Junction, T_J ⁽⁶⁾	-40	150	
	Storage, T_{stg}	-65	150	

(1) Stresses above these ratings may cause permanent damage. Exposure to absolute maximum conditions for extended periods may degrade device reliability. These are stress ratings only, and functional operation of the device at these or any other conditions beyond those specified is not implied.

(2) Input terminals are diode-clamped to the power-supply rails. Input signals that can swing more than 0.3V beyond the supply rails should be current-limited to 10mA or less.

(3) Output terminals are diode-clamped to the power-supply rails. Output signals that can swing more than 0.3V beyond the supply rails should be current-limited to ± 55 mA or less.

(4) Short-circuit from output to V_S can cause excessive heating and eventual destruction.

(5) The package thermal impedance is calculated in accordance with JEDEC-51.

(6) The maximum power dissipation is a function of $T_{J(MAX)}$, $R_{\theta JA}$, and T_A . The maximum allowable power dissipation at any ambient temperature is $P_D = (T_{J(MAX)} - T_A) / R_{\theta JA}$. All numbers apply for packages soldered directly onto a PCB.

7.2 ESD Ratings

The following ESD information is provided for handling of ESD-sensitive devices in an ESD protected area only.

		VALUE	UNIT
$V_{(ESD)}$	Electrostatic discharge	Human-Body Model (HBM), per ANSI/ESDA/JEDEC JS-001, all pins ⁽¹⁾	± 2000
		Charged Device Model (CDM), per JEDEC specification JESD22-C101, all pins ⁽²⁾	± 1000

(1) JEDEC document JEP155 states that 500V HBM allows safe manufacturing with a standard ESD control process.

(2) JEDEC document JEP157 states that 250V CDM allows safe manufacturing with a standard ESD control process.



ESD SENSITIVITY CAUTION

ESD damage can range from subtle performance degradation to complete device failure. Precision integrated circuits may be more susceptible to damage because very small parametric changes could cause the device not to meet its published specifications.

7.3 Recommended Operating Conditions

Over operating free-air temperature range (unless otherwise noted)

		MIN	NOM	MAX	UNIT
Supply voltage, $V_S= (V+) - (V-)$	Single-supply	3		32	V
	Dual-supply	± 1.5		± 16	

7.4 ELECTRICAL CHARACTERISTICS

(At $T_A = +25^\circ\text{C}$, $V_{CM}=(V_S/2)$, $V_S=5\text{V}$, unless otherwise noted.)⁽¹⁾

PARAMETER		CONDITIONS	LM331			UNITS
			MIN ⁽²⁾	TYP ⁽³⁾	MAX ⁽²⁾	
V_S	Operating Voltage Range		3		32	V
I_Q	Quiescent Current	$V_S=5\text{V}$, no load		65	100	μA
		$V_S=32\text{V}$, no load, $T_A=-40^\circ\text{C}$ to $+125^\circ\text{C}$		100		
V_{OS}	Input Offset Voltage	$V_S=5\text{V}$ to 32V	-7.5	± 5	7.5	mV
		$V_S=5\text{V}$ to 32V $T_A=-40^\circ\text{C}$ to $+125^\circ\text{C}$	-10		10	
I_B	Input Bias Current ⁽⁴⁾⁽⁵⁾	$T_A=25^\circ\text{C}$		10	50	pA
		$T_A=-40^\circ\text{C}$ to $+125^\circ\text{C}$			100	nA
I_{OS}	Input Offset Current ⁽⁴⁾	$T_A=25^\circ\text{C}$		10	50	pA
		$T_A=-40^\circ\text{C}$ to $+125^\circ\text{C}$			100	nA
V_{CM}	Common-Mode Voltage Range	$V_S=3\text{V}$ to 32V	(V-)+0.5		(V+)-1.5	V
		$V_S=3\text{V}$ to 32V $T_A=-40^\circ\text{C}$ to $+125^\circ\text{C}$	(V-)+0.5		(V+)-2.0	
A_{VD}	Large Signal Differential Voltage Amplification	$V_S=15\text{V}$, $V_O=1.4\text{V}$ to 11.4V $R_L \geq 15\text{k}$ to (V+)	50	200		V/mV
V_{OL}	Low-Level Output Voltage	$I_{sink} \leq 4\text{mA}$, $V_{ID}=-1\text{V}$		300	360	mV
I_{OL}	Output Current (sinking)	$V_O=1.5\text{V}$; $V_{ID}=-1\text{V}$; $V_S=5\text{V}$		15		mA
I_{LEAK}	High-Level Output Leakage Current	(V+) = $V_O=5\text{V}$; $V_{ID}=1\text{V}$		2	20	nA
		(V+) = $V_O=32\text{V}$; $V_{ID}=1\text{V}$		4	50	nA
Switching Characteristics						
T_{PHL}	Propagation Delay H To L ⁽⁶⁾	$V_S=5\text{V}$	RPU=5.1K Ω , Overdrive =10mV		0.5	μs
			RPU=5.1K Ω , Overdrive =100mV		0.3	
		$V_S=32\text{V}$	RPU=5.1K Ω , Overdrive =10mV		0.64	
			RPU=5.1K Ω , Overdrive =100mV		0.5	
T_{PLH}	Propagation Delay L To H ⁽⁶⁾	$V_S=5\text{V}$	RPU=5.1K Ω , Overdrive =10mV		1.5	
			RPU=5.1K Ω , Overdrive =100mV		0.3	
		$V_S=32\text{V}$	RPU=5.1K Ω , Overdrive =10mV		1.5	
			RPU=5.1K Ω , Overdrive =100mV		0.25	

NOTE:

- (1) Electrical table values apply only for factory testing conditions at the temperature indicated. Factory testing conditions result in very limited self-heating of the device.
- (2) Limits are 100% production tested at 25°C . Limits over the operating temperature range are ensured through correlations using statistical quality control (SQC) method.
- (3) Typical values represent the most likely parametric norm as determined at the time of characterization. Actual typical values may vary over time and will also depend on the application and configuration.
- (4) This parameter is ensured by design and/or characterization and is not tested in production.
- (5) Positive current corresponds to current flowing into the device.
- (6) High-to-low and low-to-high refers to the transition at the input.

7.5 TYPICAL CHARACTERISTICS

NOTE: The graphs and tables provided following this note are a statistical summary based on a limited number of samples and are provided for informational purposes only.

At $T_A = +25^\circ\text{C}$, $V_S = 5\text{V}$, $R_{\text{PULLUP}} = 5.1\text{K}$, $V_{\text{CM}} = V_S/2$, $C_L = 15\text{pF}$, $V_{\text{OVERDRIVE}} = 100\text{mV}$, unless otherwise noted.

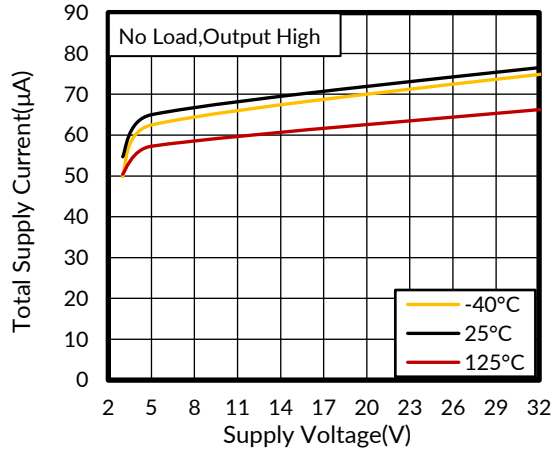

Figure 1. Total Supply Current vs Supply Voltage

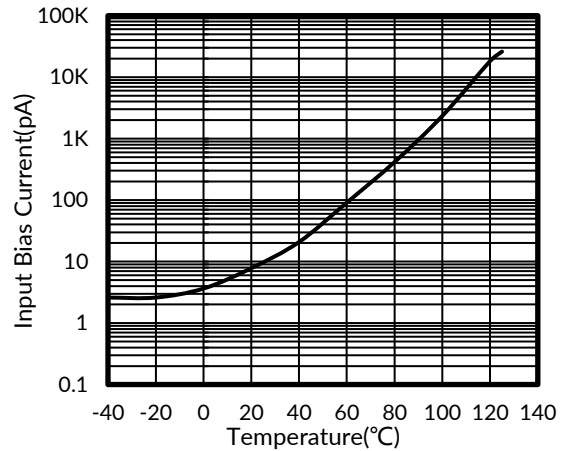

Figure 2. INPUT BIAS CURRENT vs TEMPERATURE

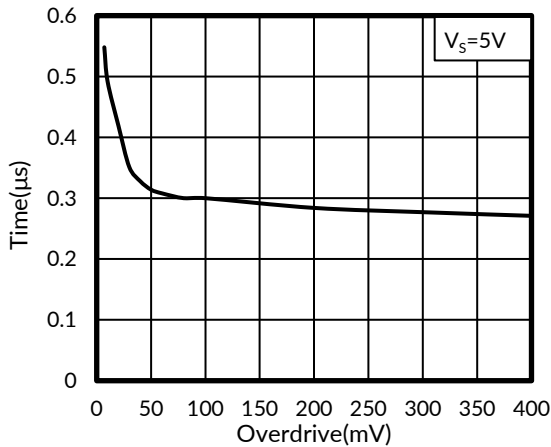

Figure 3. Response Time vs Input Overdrives Negative Transition

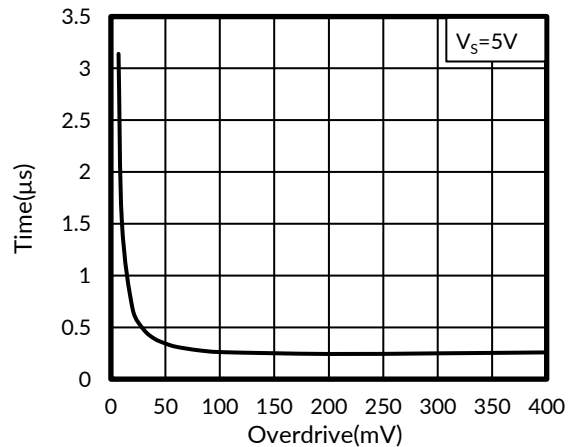

Figure 4. Response Time vs Input Overdrives Positive Transition

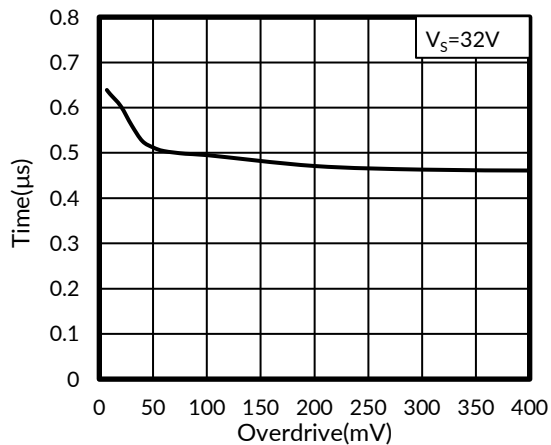

Figure 5. Response Time vs Input Overdrives Negative Transition

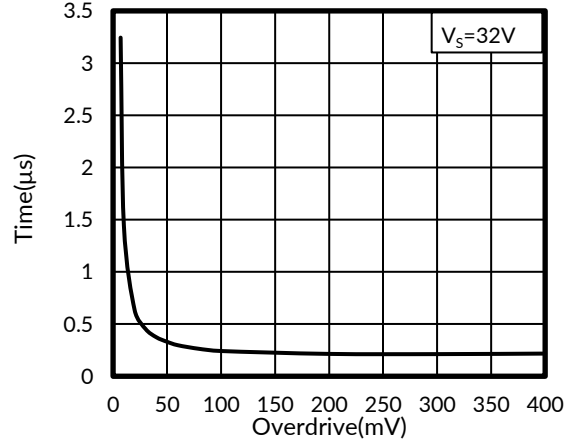

Figure 6. Response Time vs Input Overdrives Positive Transition

8 Detailed Description

8.1 Overview

The LM331 family of comparators can operate up to 32V on the supply pin. This standard device has proven ubiquity and versatility across a wide range of applications. This is due to its low power and high speed. The open-drain output allows the user to configure the output's logic low voltage (V_{OL}) and can be utilized to enable the comparator to be used in AND functionality.

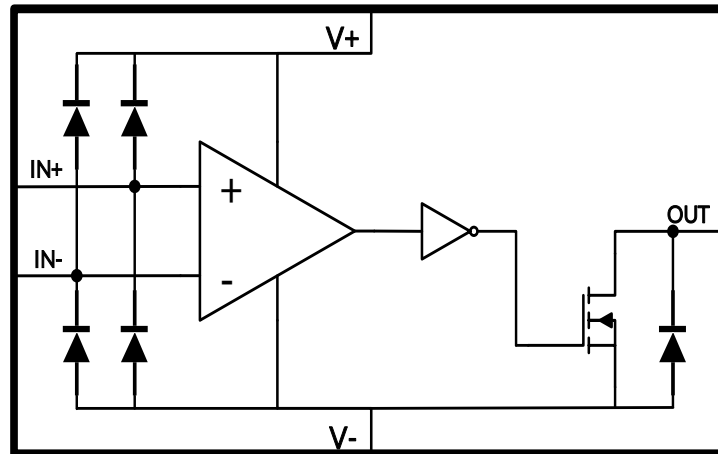

Figure 7. Functional Block Diagram

9 Application and Implementation

Information in the following applications sections is not part of the Runic component specification, and Runic does not warrant its accuracy or completeness. Runic's customers are responsible for determining suitability of components for their purposes. Customers should validate and test their design implementation to confirm system functionality.

9.1 Application Information

LM331 is typically used to compare a single signal to a reference or two signals against each other. Many users take advantage of the open drain output (logic high with pull-up) to drive the comparison logic output to a logic voltage level to an MCU or logic device. The wide supply range and high voltage capability makes this comparator optimal for level shifting to a higher or lower voltage.

9.2 Typical Application

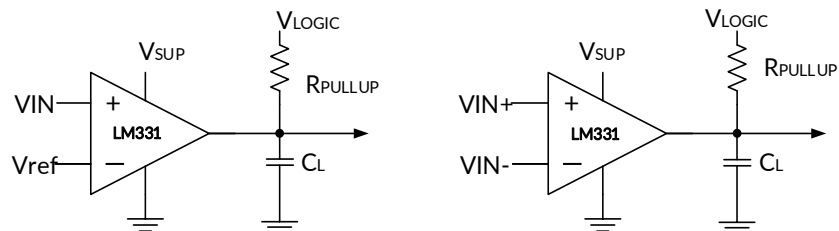

Figure 8. Single-Ended and Differential Comparator Configurations

9.3 Detailed Design Procedure

When using the device in a general comparator application, determine the following:

- Input Voltage Range
- Minimum Overdrive Voltage
- Output and Drive Current
- Response Time

9.4 Input Voltage Range

When choosing the input voltage range, the input common mode voltage range (VICR) must be taken in to account. If temperature operation is below 25°C the VICR can range from 0 V to $V_S - 2.0$ V. This limits the input voltage range to as high as $V_S - 2.0$ V and as low as 0 V. Operation outside of this range can yield incorrect comparisons.

10 PACKAGE OUTLINE DIMENSIONS

SOT23-5⁽³⁾

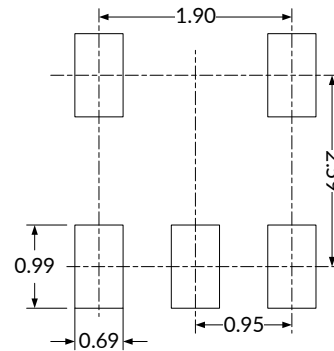
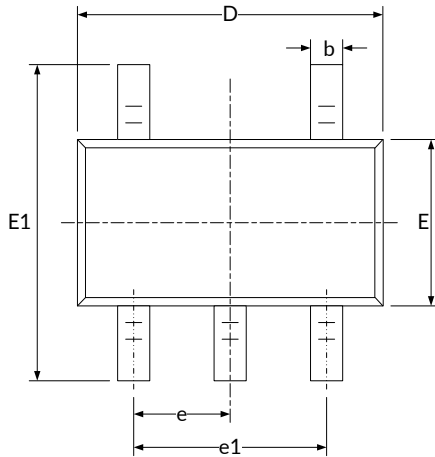
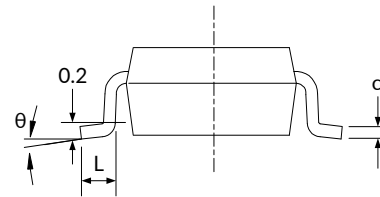
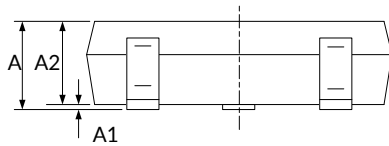
RECOMMENDED LAND PATTERN (Unit: mm)

Symbol	Dimensions In Millimeters		Dimensions In Inches	
	Min	Max	Min	Max
A ⁽¹⁾	1.050	1.250	0.041	0.049
A1	0.000	0.100	0.000	0.004
A2	1.050	1.150	0.041	0.045
b	0.300	0.500	0.012	0.020
c	0.100	0.200	0.004	0.008
D ⁽¹⁾	2.820	3.020	0.111	0.119
E ⁽¹⁾	1.500	1.700	0.059	0.067
E1	2.650	2.950	0.104	0.116
e	0.950(BSC) ⁽²⁾		0.037(BSC) ⁽²⁾	
e1	1.800	2.000	0.071	0.079
L	0.300	0.600	0.012	0.024
θ	0°	8°	0°	8°

NOTE:

1. Plastic or metal protrusions of 0.15mm maximum per side are not included.
2. BSC (Basic Spacing between Centers), "Basic" spacing is nominal.
3. This drawing is subject to change without notice.

11 TAPE AND REEL INFORMATION

REEL DIMENSIONS

TAPE DIMENSION

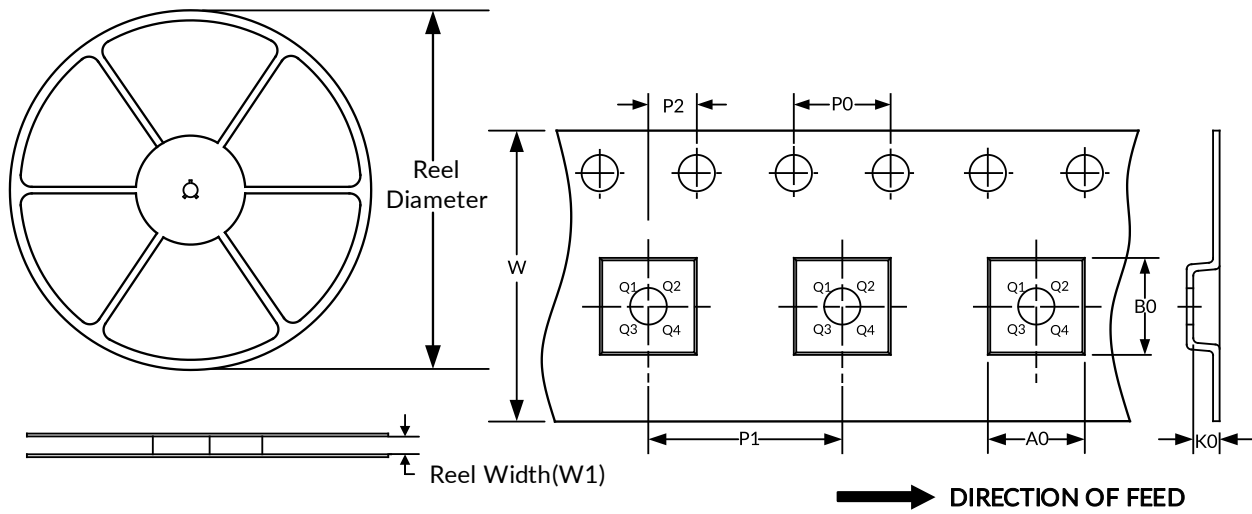

NOTE: The picture is only for reference. Please make the object as the standard.

KEY PARAMETER LIST OF TAPE AND REEL

Package Type	Reel Diameter	Reel Width (mm)	A0 (mm)	B0 (mm)	K0 (mm)	P0 (mm)	P1 (mm)	P2 (mm)	W (mm)	Pin1 Quadrant
SOT23-5	7"	9.5	3.20	3.20	1.40	4.0	4.0	2.0	8.0	Q3

NOTE:

1. All dimensions are nominal.
2. Plastic or metal protrusions of 0.15mm maximum per side are not included.

IMPORTANT NOTICE AND DISCLAIMER

Jiangsu Runic Technology Co., Ltd. will accurately and reliably provide technical and reliability data (including data sheets), design resources (including reference designs), application or other design advice, WEB tools, safety information and other resources, without warranty of any defect, and will not make any express or implied warranty, including but not limited to the warranty of merchantability Implied warranty that it is suitable for a specific purpose or does not infringe the intellectual property rights of any third party.

These resources are intended for skilled developers designing with Runic products You will be solely responsible for: (1) Selecting the appropriate products for your application; (2) Designing, validating and testing your application; (3) Ensuring your application meets applicable standards and any other safety, security or other requirements; (4) Runic and the Runic logo are registered trademarks of Runic INCORPORATED. All trademarks are the property of their respective owners; (5) For change details, review the revision history included in any revised document. The resources are subject to change without notice. Our company will not be liable for the use of this product and the infringement of patents or third-party intellectual property rights due to its use.