

36V, 8MHz Rail-to-Rail Output CMOS Operational Amplifier

1 FEATURES

- **HIGH GAIN BANDWIDTH: 8MHz**
- **INPUT OFFSET VOLTAGE: $\pm 0.5\text{mV}$ (Typical)**
- **QUIESCENT CURRENT: 3mA/Amp**
- **Rail to Rail Output**
- **Supply Range: +5V to +36V**
- **SPECIFIED UP TO +125°C**
- **Micro SIZE PACKAGES: SOP8, MSOP8, SOP14, TSSOP14**

2 APPLICATIONS

- **SENSORS**
- **PHOTODIODE AMPLIFICATION**
- **ACTIVE FILTERS**
- **TEST EQUIPMENT**
- **DRIVING A/D CONVERTERS**

3 DESCRIPTIONS

The RS845X families of products offer high voltage (36V) operation and rail-to-rail output, as well as excellent speed/power consumption ratio, providing an excellent bandwidth (8MHz) and slew rate of 5V/us. The op-amps are unity gain stable and feature an ultra-low input bias current.

The input can operate normally within the negative power rail to 2V below of the positive power rail. The RS845X families of operational amplifiers are specified at the full temperature range of -40°C to $+125^{\circ}\text{C}$ under single power supplies of 5V to 36V or dual power supplies of $\pm 2.5\text{V}$ to $\pm 18\text{V}$.

Device Information ⁽¹⁾

PART NUMBER	PACKAGE	BODY SIZE(NOM)
RS8452	SOP8	4.90mm x 3.90mm
	MSOP8	3.00mm x 3.00mm
RS8454	SOP14	8.65mm x 3.90mm
	TSSOP14	5.00mm x 4.40mm

(1) For all available packages, see the orderable addendum at the end of the data sheet.

Table of Contents

1 FEATURES	1
2 APPLICATIONS	1
3 DESCRIPTIONS	1
4 Revision History	3
5 PACKAGE/ORDERING INFORMATION ⁽¹⁾	4
6 Pin Configuration and Functions (Top View)	5
7 SPECIFICATIONS	7
7.1 Absolute Maximum Ratings	7
7.2 ESD Ratings	7
7.3 Recommended Operating Conditions.....	7
7.4 ELECTRICAL CHARACTERISTICS	8
7.5 TYPICAL CHARACTERISTICS	10
8 PACKAGE OUTLINE DIMENSIONS	12
9 TAPE AND REEL INFORMATION	16

4 Revision History

Note: Page numbers for previous revisions may differ from page numbers in the current version.

VERSION	Change Date	Change Item
A.1	2020/12/2	Initial version completed
A.2	2021/6/21	1. Fix TSSOP-14 Package mistake in Page 12@A.1 Version 2. Added the value of Input Voltage Noise Density 3. Added the information of package size
A.3	2022/03/16	Increase the minimum junction temperature
A.4	2024/01/24	1. Added MSL on Page 7@RevA.3 2. Update ELECTRICAL CHARACTERISTICS 3. Delete SOT23-5 Package
A.4.1	2024/03/01	Modify packaging naming

5 PACKAGE/ORDERING INFORMATION ⁽¹⁾

Orderable Device	Package Type	Pin	Channel	Op Temp(°C)	Device Marking ⁽²⁾	MSL ⁽³⁾	Package Qty
RS8452XK	SOP8	8	2	-40°C ~125°C	RS8452	MSL3	Tape and Reel,4000
RS8452XM	MSOP8	8	2	-40°C ~125°C	RS8452	MSL3	Tape and Reel,4000
RS8454XP	SOP14	14	4	-40°C ~125°C	RS8454	MSL3	Tape and Reel,4000
RS8454XQ	TSSOP14	14	4	-40°C ~125°C	RS8454	MSL3	Tape and Reel,4000

NOTE:

- (1) This information is the most current data available for the designated devices. This data is subject to change without notice and revision of this document. For browser-based versions of this data sheet, refer to the right-hand navigation.
- (2) There may be additional marking, which relates to the lot trace code information (data code and vendor code), the logo or the environmental category on the device.
- (3) MSL, The Moisture Sensitivity Level rating according to the JEDEC industry standard classifications.

6 Pin Configuration and Functions (Top View)

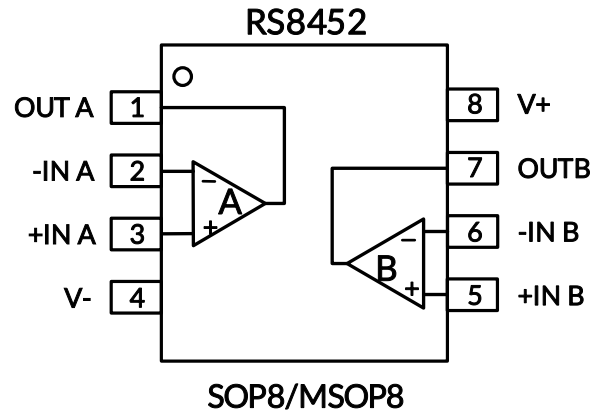

Pin Description

NAME	PIN	I/O ⁽¹⁾	DESCRIPTION
	SOP8/MSOP8		
-INA	2	I	Inverting input, channel A
+INA	3	I	Noninverting input, channel A
-INB	6	I	Inverting input, channel B
+INB	5	I	Noninverting input, channel B
OUTA	1	O	Output, channel A
OUTB	7	O	Output, channel B
V-	4	-	Negative (lowest) power supply or ground (for single supply operation)
V+	8	-	Positive (highest) power supply

(1) I = Input, O = Output.

Pin Configuration and Functions (Top View)

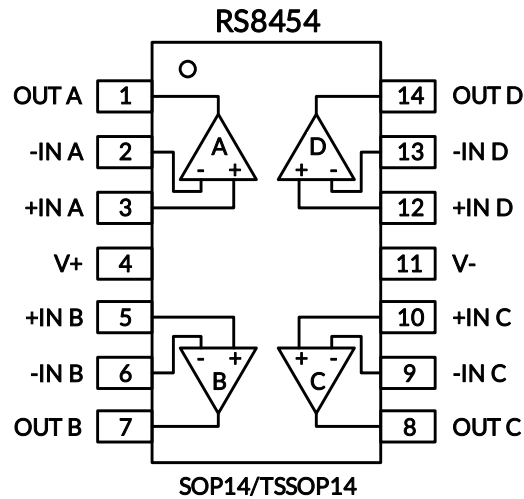

Pin Description

NAME	PIN	I/O ⁽¹⁾	DESCRIPTION
	SOP14/TSSOP14		
-INA	2	I	Inverting input, channel A
+INA	3	I	Noninverting input, channel A
-INB	6	I	Inverting input, channel B
+INB	5	I	Noninverting input, channel B
-INC	9	I	Inverting input, channel C
+INC	10	I	Noninverting input, channel C
-IND	13	I	Inverting input, channel D
+IND	12	I	Noninverting input, channel D
OUTA	1	O	Output, channel A
OUTB	7	O	Output, channel B
OUTC	8	O	Output, channel C
OUTD	14	O	Output, channel D
V-	11	-	Negative (lowest) power supply or ground (for single supply operation)
V+	4	-	Positive (highest) power supply

(1) I = Input, O = Output.

7 SPECIFICATIONS

7.1 Absolute Maximum Ratings

Over operating free-air temperature range (unless otherwise noted) ⁽¹⁾

		MIN	MAX	UNIT
Voltage	Supply, $V_S=(V+) - (V-)$	-0.7	36	V
	Signal input pin ⁽²⁾	(V-)-0.2	(V+) +0.2	
	Signal output pin ⁽³⁾	(V-)-0.2	(V+) +0.2	
Current	Signal input pin ⁽²⁾	-10	10	mA
	Signal output pin ⁽³⁾	-100	100	mA
	Output short-circuits ⁽⁴⁾	Continuous		
θ_{JA}	Package thermal impedance ⁽⁵⁾	SOP8	110	°C/W
		MSOP8	170	
		SOP14	105	
		TSSOP14	90	
Temperature	Operating range, T_A	-40	125	°C
	Junction, T_J ⁽⁶⁾	-40	150	
	Storage, T_{stg}	-55	150	

(1) Stresses above these ratings may cause permanent damage. Exposure to absolute maximum conditions for extended periods may degrade device reliability. These are stress ratings only, and functional operation of the device at these or any other conditions beyond those specified is not implied.

(2) Input terminals are diode-clamped to the power-supply rails. Input signals that can swing more than 0.2V beyond the supply rails should be current-limited to 10mA or less.

(3) Output terminals are diode-clamped to the power-supply rails. Output signals that can swing more than 0.2V beyond the supply rails should be current-limited to ± 100 mA or less.

(4) Short-circuit to ground, one amplifier per package.

(5) The package thermal impedance is calculated in accordance with JESD-51.

(6) The maximum power dissipation is a function of $T_{J(MAX)}$, $R_{\theta JA}$, and T_A . The maximum allowable power dissipation at any ambient temperature is $P_D = (T_{J(MAX)} - T_A) / R_{\theta JA}$. All numbers apply for packages soldered directly onto a PCB.

7.2 ESD Ratings

The following ESD information is provided for handling of ESD-sensitive devices in an ESD protected area only.

		VALUE	UNIT
$V_{(ESD)}$	Electrostatic discharge	Human-body model (HBM)	± 5000
		Machine Model (MM)	± 200

(1) JEDEC document JEP155 states that 500-V HBM allows safe manufacturing with a standard ESD control process.



ESD SENSITIVITY CAUTION

ESD damage can range from subtle performance degradation to complete device failure. Precision integrated circuits may be more susceptible to damage because very small parametric changes could cause the device not to meet its published specifications.

7.3 Recommended Operating Conditions

Over operating free-air temperature range (unless otherwise noted)

		MIN	NOM	MAX	UNIT
Supply voltage, $V_S=(V+) - (V-)$	Single-supply	5		36	V
	Dual-supply	± 2.5		± 18	

7.4 ELECTRICAL CHARACTERISTICS

(At $T_A = +25^\circ\text{C}$, $V_S = 5\text{V}$ to 36V , $R_L = 10\text{k}\Omega$ connected to $V_S/2$, and $V_{OUT} = V_S/2$, $V_{CM} = V_S/2$, Full ⁽⁹⁾ = -40°C to 125°C , unless otherwise noted.) ⁽¹⁾

PARAMETER	CONDITIONS	T_J	RS845X			UNITS	
			MIN ⁽²⁾	TYP ⁽³⁾	MAX ⁽²⁾		
POWER SUPPLY							
V_S	Operating Voltage Range		25°C	5		36	V
I_Q	Quiescent Current Per Amplifier	$V_S = \pm 2.5\text{V}$, $I_O = 0\text{mA}$	25°C		3.0	4.75	mA
		$V_S = \pm 18\text{V}$, $I_O = 0\text{mA}$			3.8	5.75	
PSRR	Power-Supply Rejection Ratio	$V_S = 5\text{V}$ to 36V	25°C	93	110		dB
INPUT							
V_{OS}	Input Offset Voltage	$V_{CM} = V_S/2$	25°C	-3	± 0.5	3	mV
			Full		± 1.3		
$V_{OS} T_C$	Input Offset Voltage Average Drift		Full		± 5		$\mu\text{V}/^\circ\text{C}$
I_B	Input Bias Current ⁽⁴⁾⁽⁵⁾	$V_{CM} = 0\text{V}$	25°C		10	60	pA
			Full		600		
I_{OS}	Input Offset Current ⁽⁵⁾	$V_{CM} = 0\text{V}$	25°C		10	60	pA
			Full		600		
V_{CM}	Common-Mode Voltage Range	$V_S = \pm 18\text{V}$	25°C	(V-)		(V+)-2	V
CMRR	Common-Mode Rejection Ratio	$V_S = \pm 2.5\text{V}$, $V_{CM} = (V-) \text{ to } (V+) - 2\text{V}$	25°C	70	110		dB
		$V_S = \pm 18\text{V}$, $V_{CM} = (V-) \text{ to } (V+) - 2\text{V}$	25°C	70			
OUTPUT							
A_{OL}	Open-Loop Voltage Gain	$R_L = 10\text{k}\Omega$, $V_O = (V-) + 0.6\text{V}$ to $(V+) - 0.6\text{V}$	25°C	84	100		dB
			Full		70		
V_{OH}	Output Swing	$V_S = \pm 18\text{V}$, $R_L = 10\text{k}\Omega$	25°C		17.85		V
V_{OL}						-17.85	V
I_{SC}	Short-circuit current ⁽⁶⁾⁽⁷⁾		25°C	± 55	± 100		mA
C_{LOAD}	Capacitive load drive		25°C		70		pF
FREQUENCY RESPONSE							
SR	Slew Rate ⁽⁸⁾	$G = +1$, $C_L = 70\text{pF}$	25°C		5		$\text{V}/\mu\text{s}$
GBW	Gain-Bandwidth Product		25°C		8		MHz
t_s	Settling Time, 0.01%	$V_S = \pm 2.5\text{V}$, $G = +1$, $C_L = 70\text{pF}$, Step = 2V	25°C		1.0		μs
t_{OR}	Overload Recovery Time	$V_{IN} \cdot \text{Gain} \geq V_S$, $G = 11$	25°C		1.0		μs
t_{ON}	Turn On Time		25°C		10		μs
NOISE							
E_n	Input Voltage Noise	$f = 0.1\text{Hz}$ to 10Hz , $V_S = \pm 2.5\text{V}$	25°C		7		μV_{pp}
e_n	Input Voltage Noise Density	$f = 1\text{KHz}$	25°C		35		$\text{nV}/\sqrt{\text{Hz}}$

NOTE:

- (1) Electrical table values apply only for factory testing conditions at the temperature indicated. Factory testing conditions result in very limited self-heating of the device.
- (2) Limits are 100% production tested at 25°C. Limits over the operating temperature range are ensured through correlations using statistical quality control (SQC) method.
- (3) Typical values represent the most likely parametric norm as determined at the time of characterization. Actual typical values may vary over time and will also depend on the application and configuration.
- (4) Positive current corresponds to current flowing into the device.
- (5) This parameter is ensured by design and/or characterization and is not tested in production.
- (6) The maximum power dissipation is a function of $T_{J(MAX)}$, $R_{\theta JA}$, and T_A . The maximum allowable power dissipation at any ambient temperature is $PD = (T_{J(MAX)} - T_A) / R_{\theta JA}$. All numbers apply for packages soldered directly onto a PCB.
- (7) Short circuit test is a momentary test.
- (8) Number specified is the slower of positive and negative slew rates.
- (9) Specified by characterization only.

7.5 TYPICAL CHARACTERISTICS

NOTE: The graphs and tables provided following this note are a statistical summary based on a limited number of samples and are provided for informational purposes only.

At $T_A = +25^\circ\text{C}$, $V_S = \pm 18\text{V}$, $R_L = 10\text{k}\Omega$ connected to $V_S/2$, $V_{OUT} = V_S/2$, unless otherwise noted.

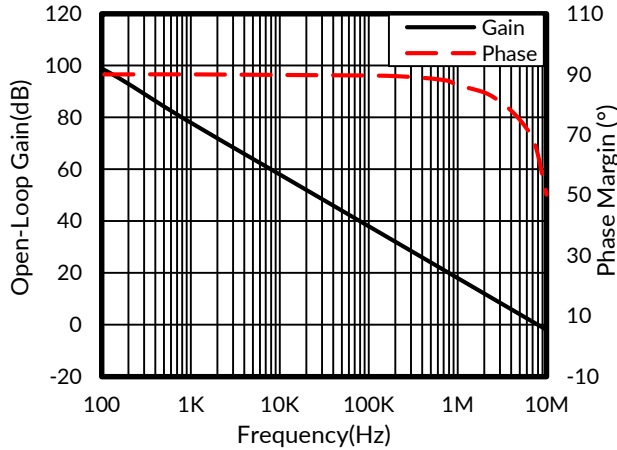

Figure 1. OPEN-LOOP GAIN AND PHASE vs FREQUENCY

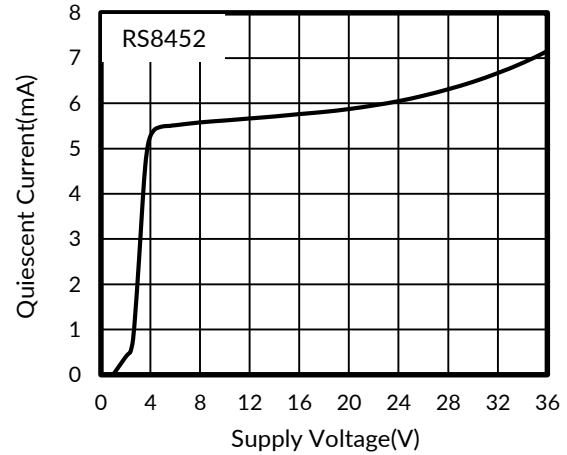

Figure 2. SUPPLY VOLTAGE vs QUIESCENT CURRENT

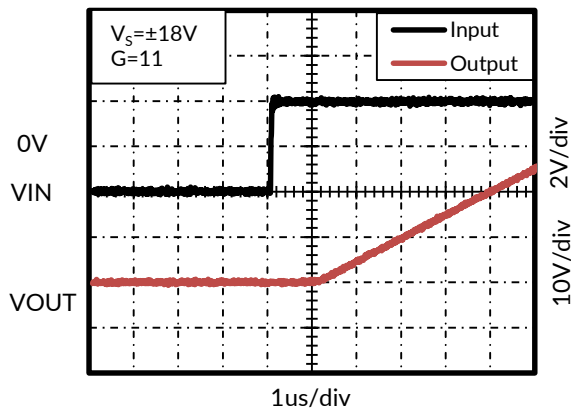

Figure 3. POSITIVE OVERVOLTAGE RECOVERY

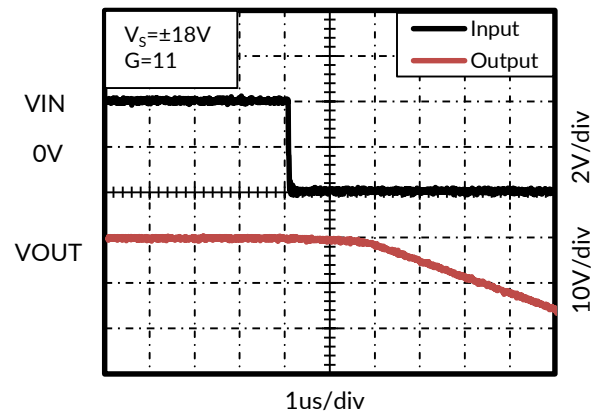

Figure 4. NEGATIVE OVERVOLTAGE RECOVERY

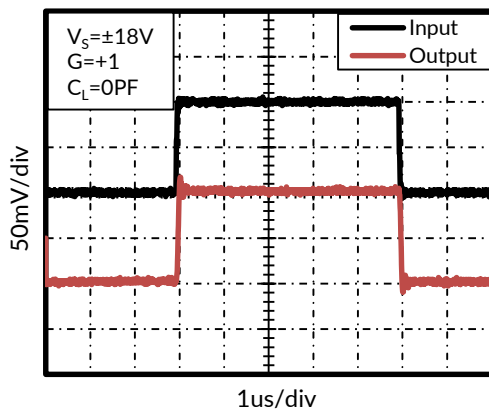

Figure 5. SMALL SIGNAL STEP RESPONSE

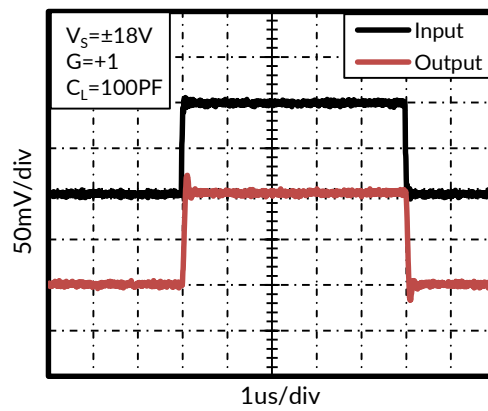

Figure 6. SMALL SIGNAL STEP RESPONSE

TYPICAL CHARACTERISTICS

NOTE: The graphs and tables provided following this note are a statistical summary based on a limited number of samples and are provided for informational purposes only.

At $T_A = +25^\circ\text{C}$, $V_S = \pm 18\text{V}$, $R_L = 10\text{k}\Omega$ connected to $V_S/2$, $V_{OUT} = V_S/2$, unless otherwise noted.

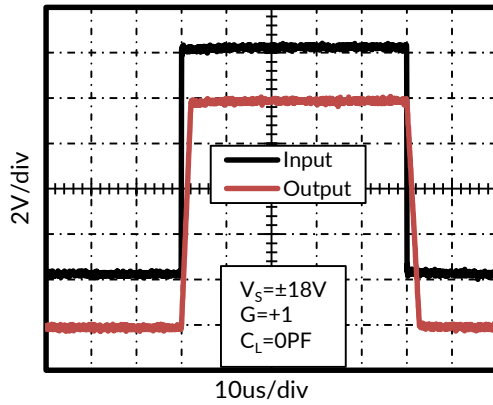

Figure 7. LARGE SIGNAL STEP RESPONSE

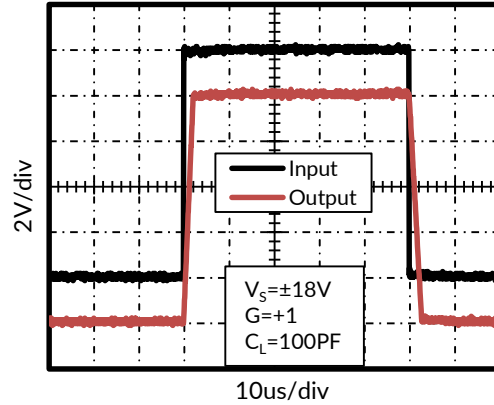

Figure 8. LARGE SIGNAL STEP RESPONSE

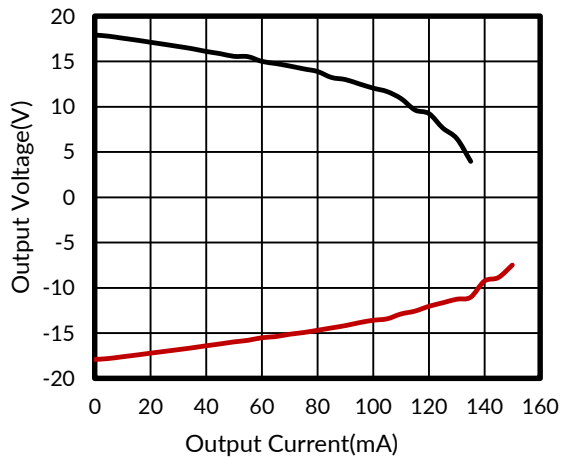

Figure 9. Output Voltage Swing vs Output Current

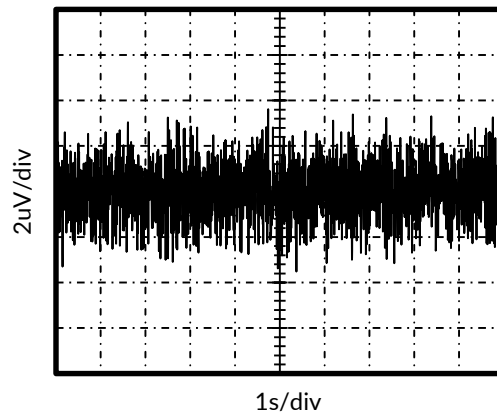
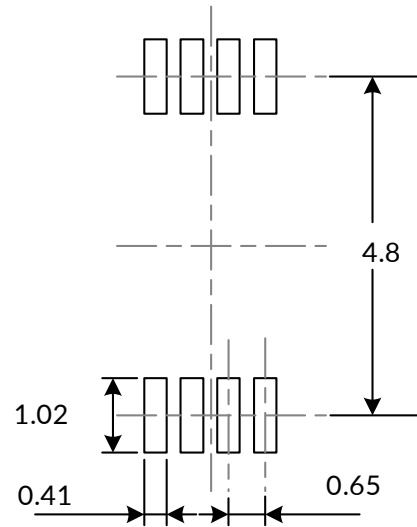
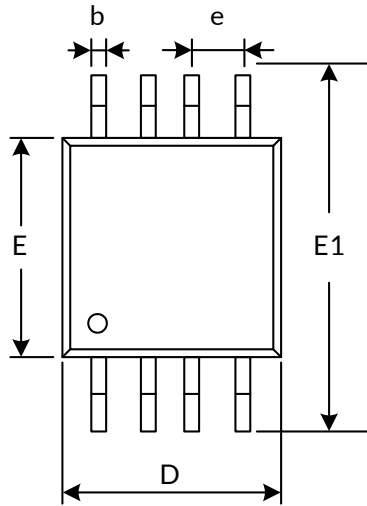
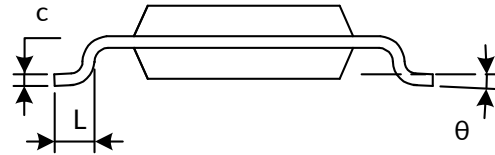
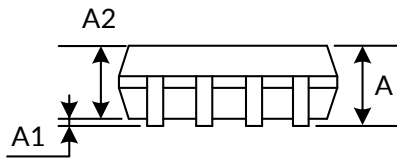

Figure 10. 0.1Hz TO 10Hz NOISE at $V_S = 5\text{V}$

8 PACKAGE OUTLINE DIMENSIONS MSOP8⁽³⁾



RECOMMENDED LAND PATTERN (Unit: mm)



Symbol	Dimensions In Millimeters		Dimensions In Inches	
	Min	Max	Min	Max
A ⁽¹⁾	0.820	1.100	0.032	0.043
A1	0.020	0.150	0.001	0.006
A2	0.750	0.950	0.030	0.037
b	0.250	0.380	0.010	0.015
c	0.090	0.230	0.004	0.009
D ⁽¹⁾	2.900	3.100	0.114	0.122
e	0.650(BSC) ⁽²⁾		0.026(BSC) ⁽²⁾	
E ⁽¹⁾	2.900	3.100	0.114	0.122
E1	4.750	5.050	0.187	0.199
L	0.400	0.800	0.016	0.031
θ	0°	6°	0°	6°

NOTE:

1. Plastic or metal protrusions of 0.15mm maximum per side are not included.
2. BSC (Basic Spacing between Centers), "Basic" spacing is nominal.
3. This drawing is subject to change without notice.

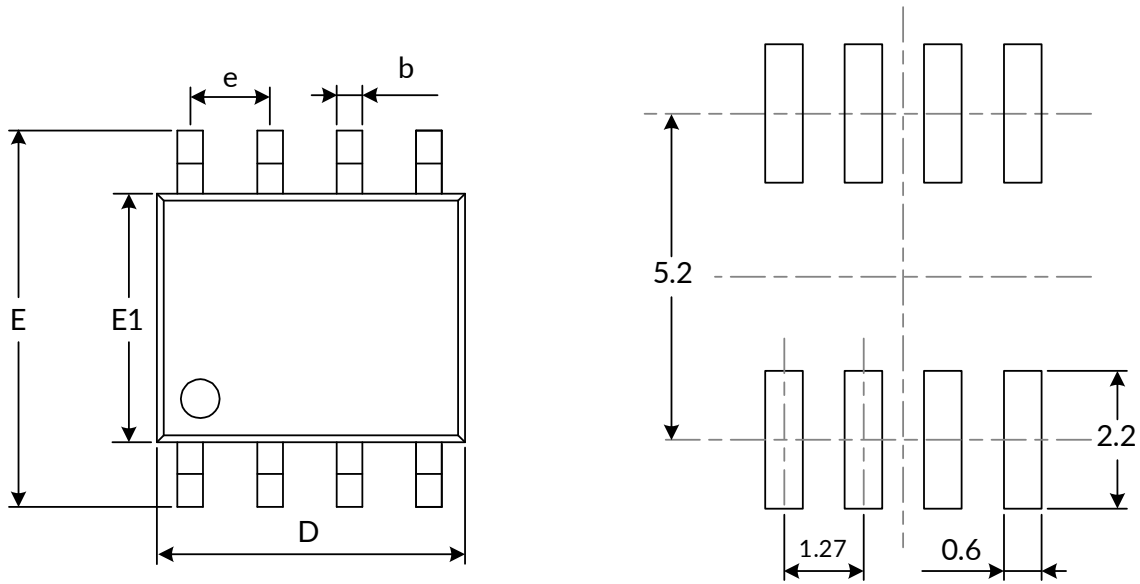
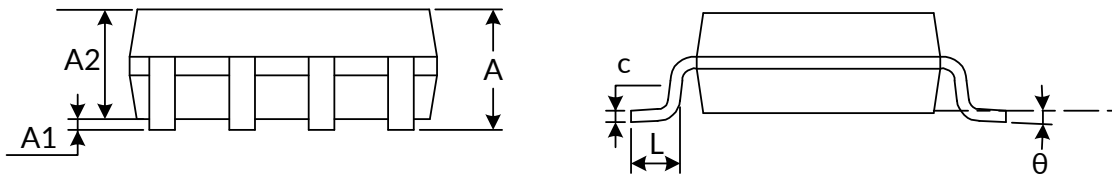
SOP8⁽³⁾

RECOMMENDED LAND PATTERN (Unit: mm)

Symbol	Dimensions In Millimeters		Dimensions In Inches	
	Min	Max	Min	Max
A ⁽¹⁾	1.350	1.750	0.053	0.069
A1	0.100	0.250	0.004	0.010
A2	1.350	1.550	0.053	0.061
b	0.330	0.510	0.013	0.020
c	0.170	0.250	0.007	0.010
D ⁽¹⁾	4.800	5.000	0.189	0.197
e	1.270(BSC) ⁽²⁾		0.050(BSC) ⁽²⁾	
E	5.800	6.200	0.228	0.244
E1 ⁽¹⁾	3.800	4.000	0.150	0.157
L	0.400	1.270	0.016	0.050
θ	0°	8°	0°	8°

NOTE:

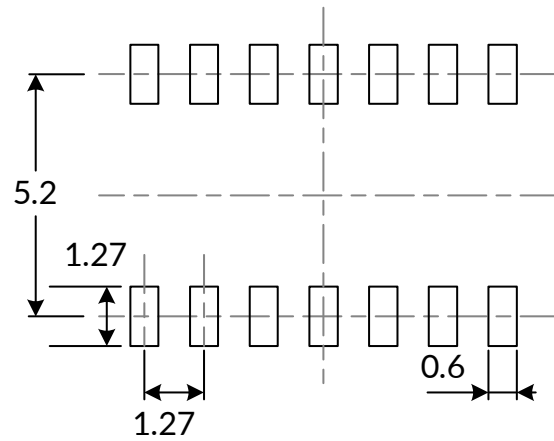
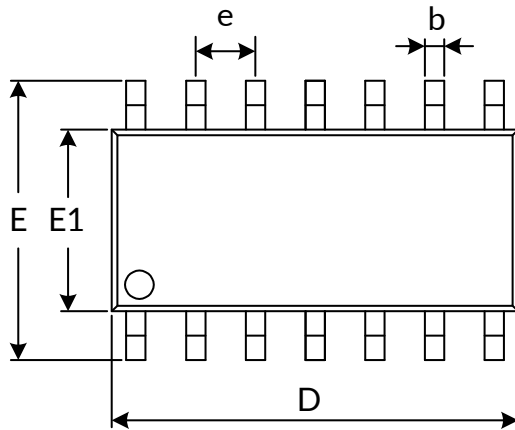
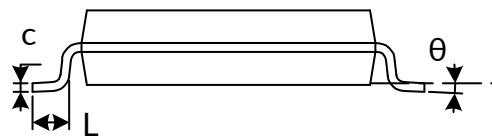
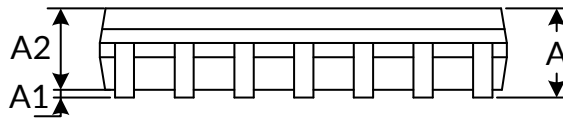
1. Plastic or metal protrusions of 0.15mm maximum per side are not included.
2. BSC (Basic Spacing between Centers), "Basic" spacing is nominal.
3. This drawing is subject to change without notice.

SOP14⁽³⁾

RECOMMENDED LAND PATTERN (Unit: mm)

Symbol	Dimensions In Millimeters		Dimensions In Inches	
	Min	Max	Min	Max
A ⁽¹⁾	1.350	1.750	0.053	0.069
A1	0.100	0.250	0.004	0.010
A2	1.350	1.550	0.053	0.061
b	0.310	0.510	0.012	0.020
c	0.100	0.250	0.004	0.010
D ⁽¹⁾	8.450	8.850	0.333	0.348
e	1.270(BSC) ⁽²⁾		0.050(BSC) ⁽²⁾	
E	5.800	6.200	0.228	0.244
E1 ⁽¹⁾	3.800	4.000	0.150	0.157
L	0.400	1.270	0.016	0.050
θ	0°	8°	0°	8°

NOTE:

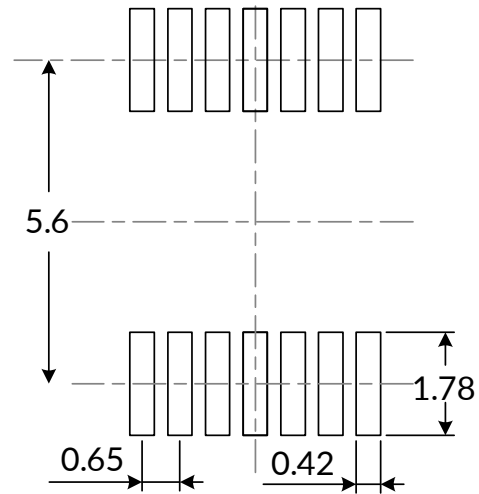
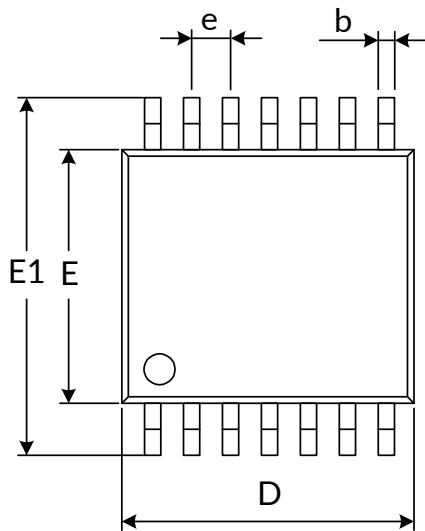
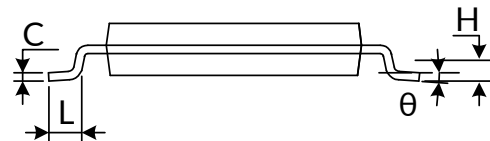
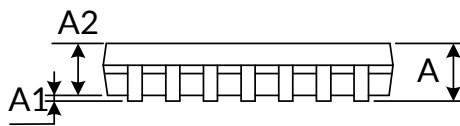
1. Plastic or metal protrusions of 0.15mm maximum per side are not included.
2. BSC (Basic Spacing between Centers), "Basic" spacing is nominal.
3. This drawing is subject to change without notice.

TSSOP14⁽³⁾

RECOMMENDED LAND PATTERN (Unit: mm)

Symbol	Dimensions In Millimeters		Dimensions In Inches	
	Min	Max	Min	Max
A ⁽¹⁾		1.200		0.047
A1	0.050	0.150	0.002	0.006
A2	0.800	1.050	0.031	0.041
b	0.190	0.300	0.007	0.012
c	0.090	0.200	0.004	0.008
D ⁽¹⁾	4.860	5.100	0.191	0.201
E ⁽¹⁾	4.300	4.500	0.169	0.177
E1	6.250	6.550	0.246	0.258
e	0.650(BSC) ⁽²⁾		0.026(BSC) ⁽²⁾	
L	0.500	0.700	0.020	0.028
H	0.25(TYP)		0.01(TYP)	
θ	1°	7°	1°	7°

NOTE:

1. Plastic or metal protrusions of 0.15mm maximum per side are not included.
2. BSC (Basic Spacing between Centers), "Basic" spacing is nominal.
3. This drawing is subject to change without notice.

9 TAPE AND REEL INFORMATION

REEL DIMENSIONS

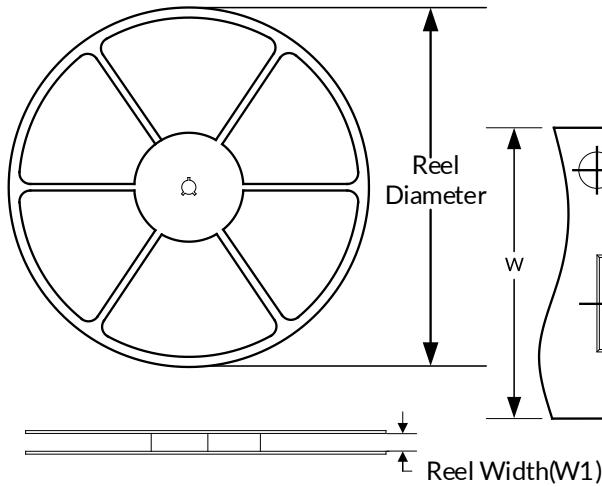

TAPE DIMENSION

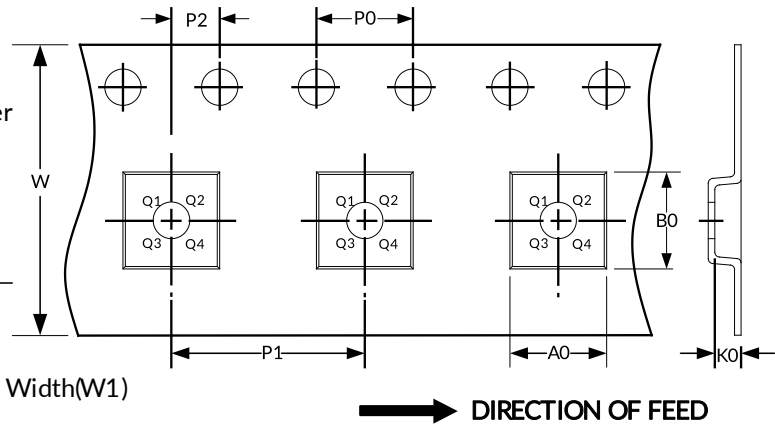

NOTE: The picture is only for reference. Please make the object as the standard.

KEY PARAMETER LIST OF TAPE AND REEL

Package Type	Reel Diameter	Reel Width W1(mm)	A0 (mm)	B0 (mm)	K0 (mm)	P0 (mm)	P1 (mm)	P2 (mm)	W (mm)	Pin1 Quadrant
SOP8	13"	12.4	6.40	5.40	2.10	4.0	8.0	2.0	12.0	Q1
MSOP8	13"	12.4	5.20	3.30	1.50	4.0	8.0	2.0	12.0	Q1
SOP14	13"	16.4	6.60	9.30	2.10	4.0	8.0	2.0	16.0	Q1
TSSOP14	13"	12.4	6.95	5.60	1.20	4.0	8.0	2.0	12.0	Q1

NOTE:

1. All dimensions are nominal.
2. Plastic or metal protrusions of 0.15mm maximum per side are not included.

IMPORTANT NOTICE AND DISCLAIMER

Jiangsu Runic Technology Co., Ltd. will accurately and reliably provide technical and reliability data (including data sheets), design resources (including reference designs), application or other design advice, WEB tools, safety information and other resources, without warranty of any defect, and will not make any express or implied warranty, including but not limited to the warranty of merchantability Implied warranty that it is suitable for a specific purpose or does not infringe the intellectual property rights of any third party.

These resources are intended for skilled developers designing with Runic products You will be solely responsible for: (1) Selecting the appropriate products for your application; (2) Designing, validating and testing your application; (3) Ensuring your application meets applicable standards and any other safety, security or other requirements; (4) Runic and the Runic logo are registered trademarks of Runic INCORPORATED. All trademarks are the property of their respective owners; (5) For change details, review the revision history included in any revised document. The resources are subject to change without notice. Our company will not be liable for the use of this product and the infringement of patents or third-party intellectual property rights due to its use.