Table of Contents

1 FEATURES	1
2 APPLICATIONS	1
3 DESCRIPTIONS	1
4 Functional Block Diagram	1
5 Revision History	3
6 PACKAGE/ORDERING INFORMATION ⁽¹⁾	4
7 Pin Configuration and Functions (Top View)	5
8 SPECIFICATIONS	7
8.1 Absolute Maximum Ratings	7
8.2 ESD Ratings	7
8.3 Recommended Operating Conditions	7
8.4 ELECTRICAL CHARACTERISTICS	8
8.5 TYPICAL APPLICATION CIRCUIT	9
8.6 TYPICAL PERFORMANCE CHARACTERISTICS	10
9 PACKAGE OUTLINE DIMENSIONS	13
10 TAPE AND REEL INFORMATION	16

5 Revision History

Note: Page numbers for previous revisions may differ from page numbers in the current version.

VERSION	Change Date	Change Item
B.0	2019/03/24	Initial version completed
B.1	2020/01/15	1. Added output voltage 2. Added SOT23-3 package
B.2	2021/11/18	Change SOT23-5 and SOT23-3 Thermal Information on Page 6 @B.1 Version.
B.3	2023/09/20	1. Update ELECTRICAL CHARACTERISTICS 2. Update Input Voltage
B.3.1	2024/03/07	Modify packaging naming

6 PACKAGE/ORDERING INFORMATION (1)

MODEL	V _{OUT} (V)	PIN- PACKAGE	ORDERING NUMBER	PACKAGE MARKING ⁽²⁾	PACKAGE OPTION
RS3219-1.2	1.2V	XDFN1X1-4	RS3219-1.2YUTDN4	AC	Tape and Reel, 10000
RS3219-1.5	1.5V	XDFN1X1-4	RS3219-1.5YUTDN4	AD	Tape and Reel, 10000
RS3219-1.8	1.8V	XDFN1X1-4	RS3219-1.8YUTDN4	AE	Tape and Reel, 10000
RS3219-2.5	2.5V	XDFN1X1-4	RS3219-2.5YUTDN4	AG	Tape and Reel, 10000
RS3219-2.8	2.8V	XDFN1X1-4	RS3219-2.8YUTDN4	AH	Tape and Reel, 10000
RS3219-3.0	3.0V	XDFN1X1-4	RS3219-3.0YUTDN4	AI	Tape and Reel, 10000
RS3219-3.3	3.3V	XDFN1X1-4	RS3219-3.3YUTDN4	AJ	Tape and Reel, 10000
RS3219-1.2	1.2V	SOT23-5	RS3219-1.2YF5	LA12	Tape and Reel, 3000
RS3219-1.5	1.5V	SOT23-5	RS3219-1.5YF5	LA15	Tape and Reel, 3000
RS3219-1.8	1.8V	SOT23-5	RS3219-1.8YF5	LA18	Tape and Reel, 3000
RS3219-2.5	2.5V	SOT23-5	RS3219-2.5YF5	LA25	Tape and Reel, 3000
RS3219-2.8	2.8V	SOT23-5	RS3219-2.8YF5	LA28	Tape and Reel, 3000
RS3219-3.0	3.0V	SOT23-5	RS3219-3.0YF5	LA30	Tape and Reel, 3000
RS3219-3.3	3.3V	SOT23-5	RS3219-3.3YF5	LA33	Tape and Reel, 3000
RS3219-1.2	1.2V	SOT23-3	RS3219-1.2YF3	LA12	Tape and Reel, 3000
RS3219-1.5	1.5V	SOT23-3	RS3219-1.5YF3	LA15	Tape and Reel, 3000
RS3219-1.8	1.8V	SOT23-3	RS3219-1.8YF3	LA18	Tape and Reel, 3000
RS3219-2.5	2.5V	SOT23-3	RS3219-2.5YF3	LA25	Tape and Reel, 3000
RS3219-2.8	2.8V	SOT23-3	RS3219-2.8YF3	LA28	Tape and Reel, 3000
RS3219-3.0	3.0V	SOT23-3	RS3219-3.0YF3	LA30	Tape and Reel, 3000
RS3219-3.3	3.3V	SOT23-3	RS3219-3.3YF3	LA33	Tape and Reel, 3000

NOTE:

- (1) This information is the most current data available for the designated devices. This data is subject to change without notice and revision of this document. For browser-based versions of this data sheet, refer to the right-hand navigation.
- (2) There may be additional marking, which relates to the lot trace code information(data code and vendor code), the logo or the environmental category on the device.

7 Pin Configuration and Functions (Top View)

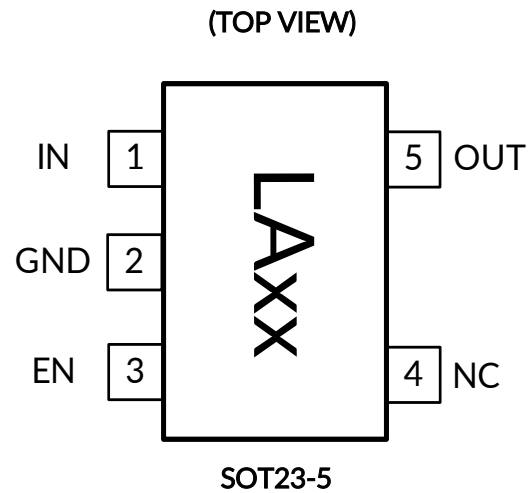
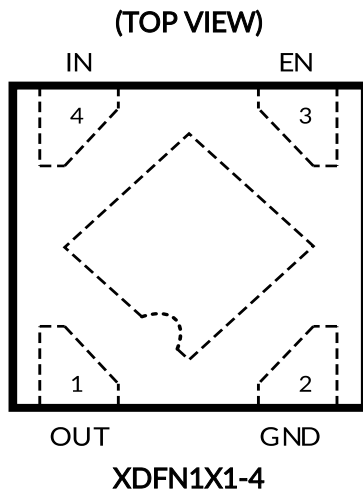

XDFN1X1-4		I/O ⁽¹⁾	DESCRIPTION
NUMBER	NAME		
1	OUT	O	Regulator Output.
2	GND	G	Ground.
3	EN	I	Enable Input. A logic low reduces the supply current to 10nA. Connect to IN for normal operation.
4	IN	I	Regulator Input. Supply voltage can range from 2.5V to 7.5V. Bypass with a 1 μ F capacitor to GND.
Thermal Pad	-	-	Connect the thermal pad to a large-area ground plane. This pad is not an electrical connection to the device ground.

(1) I=input, O=output, G= Ground.

SOT23-5		I/O ⁽¹⁾	DESCRIPTION
NUMBER	NAME		
1	IN	I	Regulator Input. Supply voltage can range from 2.5V to 7.5V. Bypass with a 1 μ F capacitor to GND.
2	GND	G	Ground.
3	EN	I	Enable Input. A logic low reduces the supply current to 10nA. Connect to IN for normal operation.
4	NC	-	No internal connect.
5	OUT	O	Regulator Output.

(1) I=input, O=output, G= Ground.

Pin Configuration and Functions (Top View)

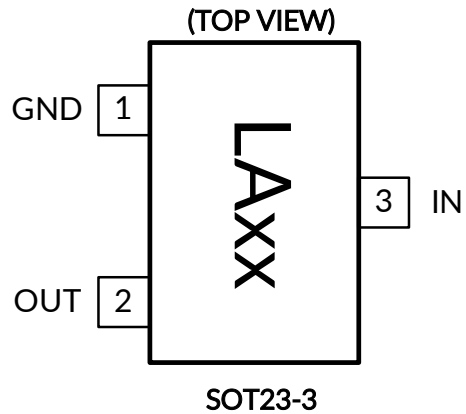

SOT23-3		I/O ⁽¹⁾	DESCRIPTION
NUMBER	NAME		
1	GND	G	Ground.
2	OUT	O	Regulator Output.
3	IN	I	Regulator Input. Supply voltage can range from 2.5V to 7.5V. Bypass with a 1 μ F capacitor to GND.

(1) I=input, O=output, G= Ground.

8 SPECIFICATIONS

8.1 Absolute Maximum Ratings

over operating free-air temperature range (unless otherwise noted) ⁽¹⁾ ⁽²⁾

		MIN	MAX	UNIT
V _{IN}	Input voltage	-0.3	8	V
V _{OUT}	Output voltage	-0.3	V _{IN} + 0.3	V
V _{EN}	Enable input voltage	-0.3	V _{IN}	V
θ _{JA}	Package thermal impedance ⁽³⁾	SOT23-5	230	°C/W
		SOT23-3	295	
		XDFN1X1-4	315	
T _J	Junction temperature ⁽⁴⁾		150	°C
P _D	Continuous power dissipation ⁽⁵⁾	Internally Limited		W
T _{stg}	Storage temperature	-65	150	°C

- (1) Stresses beyond those listed under Absolute Maximum Ratings may cause permanent damage to the device. These are stress ratings only, and functional operation of the device at these or any other conditions beyond those indicated under Recommended Operating Conditions is not implied. Exposure to absolute-maximum-rated conditions for extended periods may affect device reliability.
- (2) All voltages are with respect to the GND pin.
- (3) The package thermal impedance is calculated in accordance with JESD-51.
- (4) The maximum power dissipation is a function of T_{J(MAX)}, R_{θJA}, and T_A. The maximum allowable power dissipation at any ambient temperature is P_D = (T_{J(MAX)} - T_A) / R_{θJA}. All numbers apply for packages soldered directly onto a PCB.
- (5) Internal thermal shutdown circuitry protects the device from permanent damage.

8.2 ESD Ratings

The following ESD information is provided for handling of ESD-sensitive devices in an ESD protected area only.

		VALUE	UNIT	
V _(ESD)	Electrostatic discharge	Human-body model (HBM)	±4000	V
		Machine model (MM)	±200	V



ESD SENSITIVITY CAUTION

ESD damage can range from subtle performance degradation to complete device failure. Precision integrated circuits may be more susceptible to damage because very small parametric changes could cause the device not to meet its published specifications.

8.3 Recommended Operating Conditions

over operating free-air temperature range (unless otherwise noted) ⁽¹⁾

		MIN	MAX	UNIT
V _{IN}	Input supply voltage	2.5	7.5	V
V _{OUT}	Output voltage	1.2	5	V
V _{EN}	Enable input voltage	0	V _{IN}	V
I _{OUT}	Output current	0	300	mA
T _J	Junction temperature	-40	85	°C

- (1) All voltages are with respect to the GND pin.

8.4 ELECTRICAL CHARACTERISTICS

($V_{IN} = V_{OUT(NOMINAL)} + 0.5V$ ⁽¹⁾, Full = -40°C to +85°C, unless otherwise noted.)

PARAMETER	SYMBOL	CONDITIONS	TEMP	MIN	TYP	MAX	UNITS	
Input Voltage	V_{IN}		+25°C	2.5 ⁽¹⁾		7.5	V	
Output Voltage Accuracy ⁽¹⁾		$I_{OUT} = 0.1mA$	+25°C	-2.5		+2.5	%	
Maximum Output Current ⁽¹⁾			+25°C	300			mA	
Ground Pin Current	I_Q	No load, $EN = V_{IN}$	+25°C		120	200	μA	
Dropout Voltage ⁽²⁾		$I_{OUT} = 1mA$, $V_{OUT}=3.3V$	+25°C		0.95		mV	
		$I_{OUT} = 300mA$, $V_{OUT}=3.3V$			280	400		
Line Regulation ⁽¹⁾	ΔV_{LNR}	$V_{IN} = 2.5V$ or $(V_{OUT} + 0.5V)$ to 5.5V, $I_{OUT} = 1mA$	+25°C		0.03	0.09	%/V	
Load Regulation	ΔV_{LDR}	$I_{OUT} = 0.1mA$ to 300mA, $C_{OUT} = 1\mu F$,	+25°C		0.002	0.005	%/mA	
Output Voltage Noise	e_n	$f = 0.1Hz$ to 10Hz, $C_{OUT} = 1\mu F$	+25°C		38		μVPP	
		$f = 10Hz$ to 100kHz, $C_{OUT} = 1\mu F$, $V_{OUT}=3.3V$			40		μVrms	
Power Supply Rejection Ratio	PSRR	$I_{LOAD} = 50mA$, $C_{OUT} = 1\mu F$, $V_{IN} = V_{OUT}+1V$	$f = 217Hz$	+25°C		56		dB
			$f = 1kHz$	+25°C		55		dB
SHUTDOWN								
EN Input Threshold	V_{IH}	$V_{IN} = 2.5V$	Full	1.4			V	
	V_{IL}		Full			0.3		
	V_{IH}	$V_{IN} = 7.5V$	Full	2.0			V	
	V_{IL}		Full			0.3		
EN Input Bias Current	$I_{B(SHDN)}$	$EN = 0V$ or $EN = V_{IN}$	+25°C		0.01	1	μA	
Shutdown Supply Current	$I_{Q(SHDN)}$	$EN = 0V$	+25°C		1		μA	
Shutdown Exit Delay ⁽³⁾		$C_{OUT} = 1\mu F$, No Load	+25°C		50		μs	
THERMAL PROTECTION								
Thermal Shutdown Temperature	T_{SHDN}				150		°C	
Thermal Shutdown Hysteresis	ΔT_{SHDN}				15		°C	

NOTES:

- $V_{IN} = V_{OUT(NOMINAL)} + 0.5V$ or 2.5V, whichever is greater.
- The dropout voltage is defined as $V_{IN} - V_{OUT}$, when V_{OUT} is 100mV below the value of V_{OUT} for $V_{IN} = V_{OUT} + 0.5V$. (Only applicable for $V_{OUT} = +1.2V$ to +5.0V.)
- Time needed for V_{OUT} to reach 90% of final value.

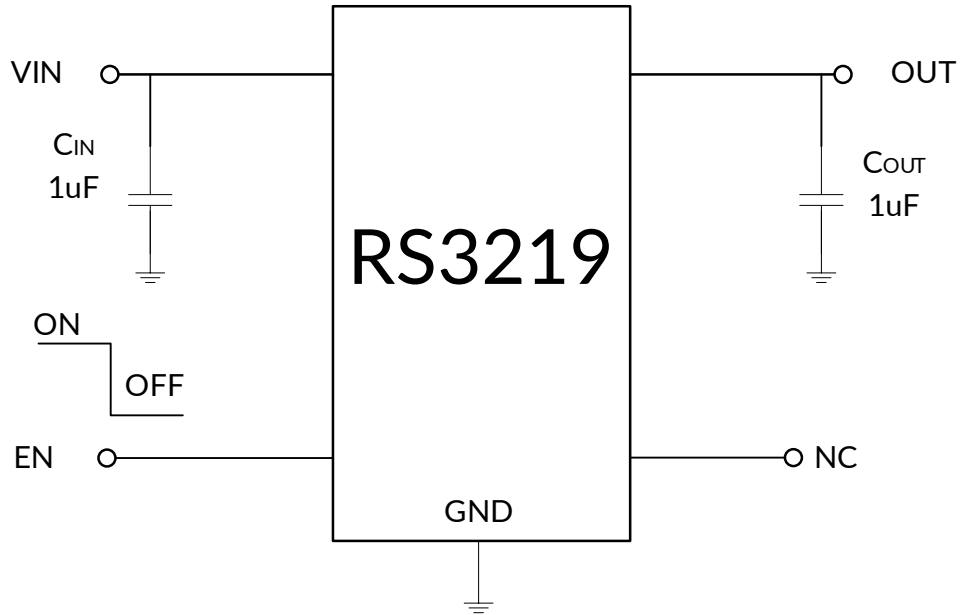
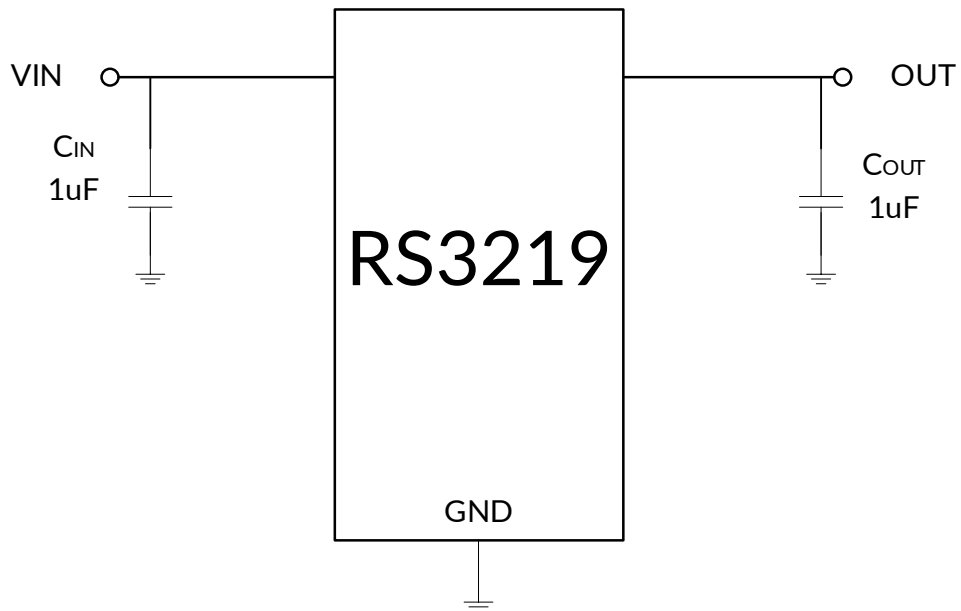
8.5 TYPICAL APPLICATION CIRCUIT**5Pin Typical Circuit****3Pin Typical Circuit**

8.6 TYPICAL PERFORMANCE CHARACTERISTICS

NOTE: The graphs and tables provided following this note are a statistical summary based on a limited number of samples and are provided for informational purposes only.

$V_{IN} = V_{OUT (NOMINAL)} + 0.5V$, $C_{IN} = 1\mu F$, $C_{OUT} = 1\mu F$, $T_A = +25^{\circ}C$, unless otherwise noted.

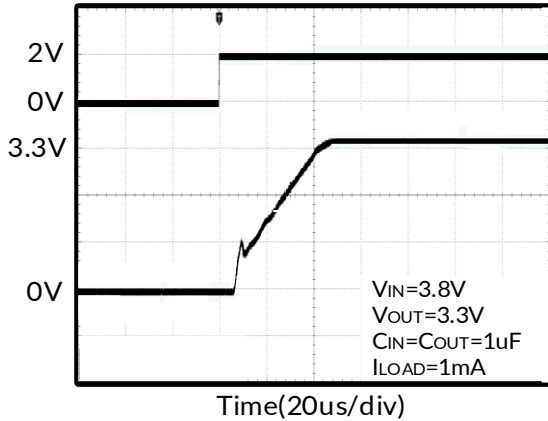

Figure 1. Start Up

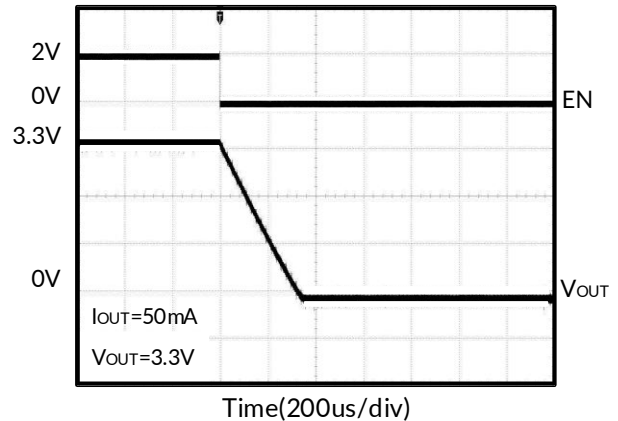

Figure 2. Shutdown

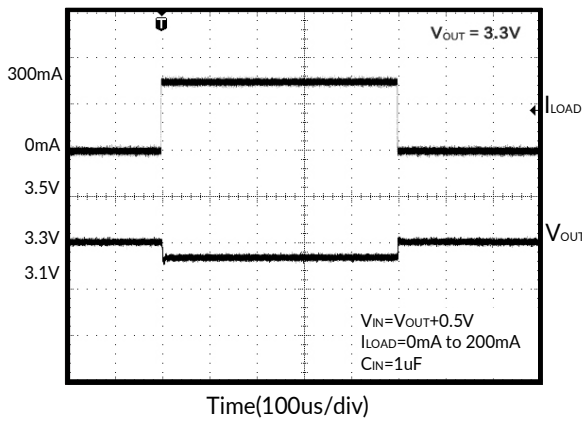

Figure 3. Load-Transient Response

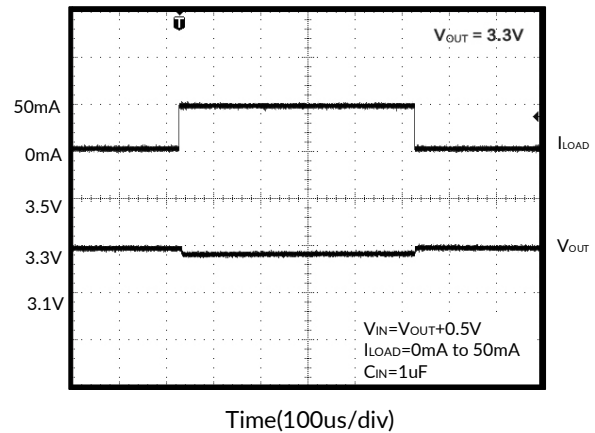

Figure 4. Load-Transient Response

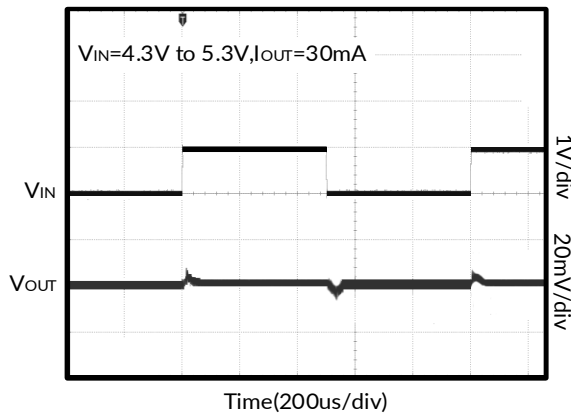

Figure 5. Line Transient Response

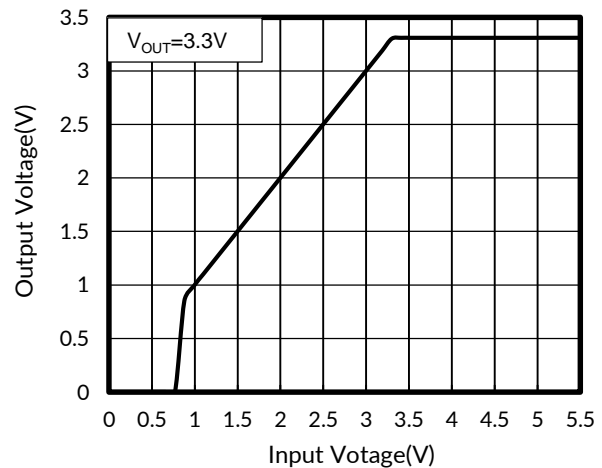

Figure 6. Output Voltage vs Input Voltage

TYPICAL PERFORMANCE CHARACTERISTICS

NOTE: The graphs and tables provided following this note are a statistical summary based on a limited number of samples and are provided for informational purposes only.

$V_{IN} = V_{OUT (NOMINAL)} + 0.5V$, $C_{IN} = 1\mu F$, $C_{OUT} = 1\mu F$, $T_A = +25^\circ C$, unless otherwise noted.

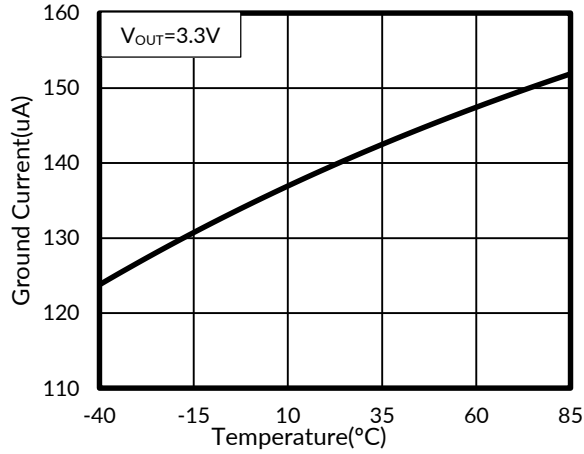

Figure 7. Ground Current vs Temperature

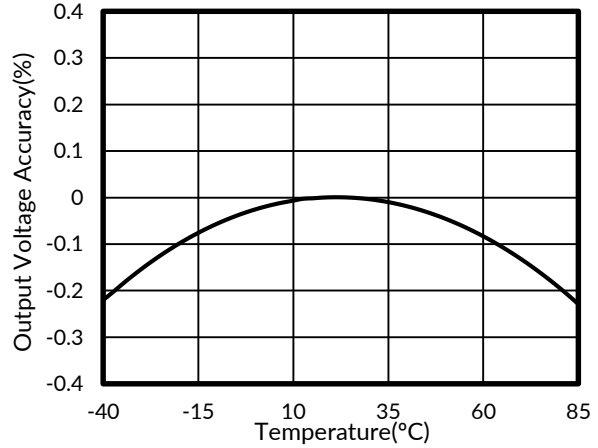

Figure 8. Output Voltage Accuracy vs Temperature

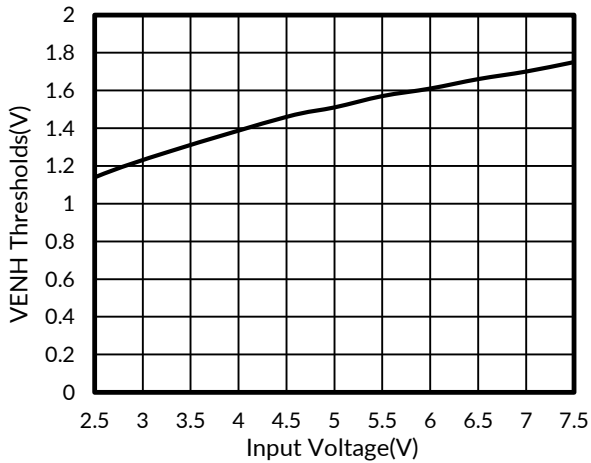

Figure 9. VENH Threshold vs Input Voltage

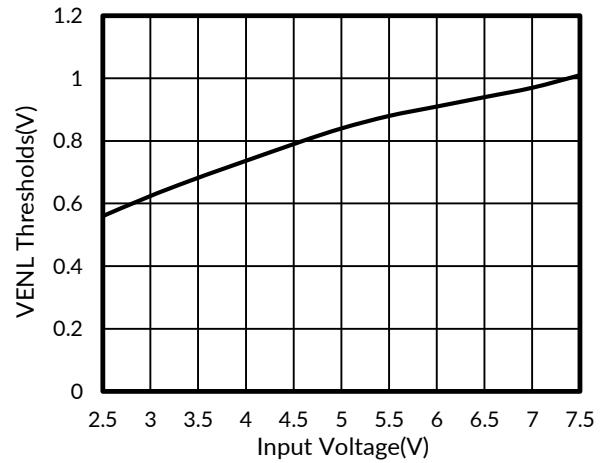

Figure 10. VENL Threshold vs Input Voltage

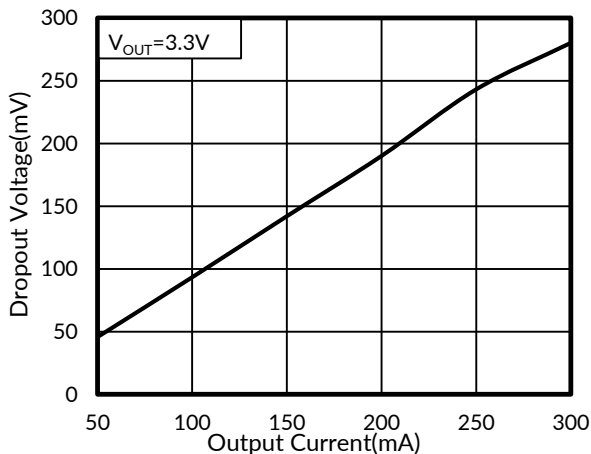

Figure 11. Dropout Voltage vs Output Current

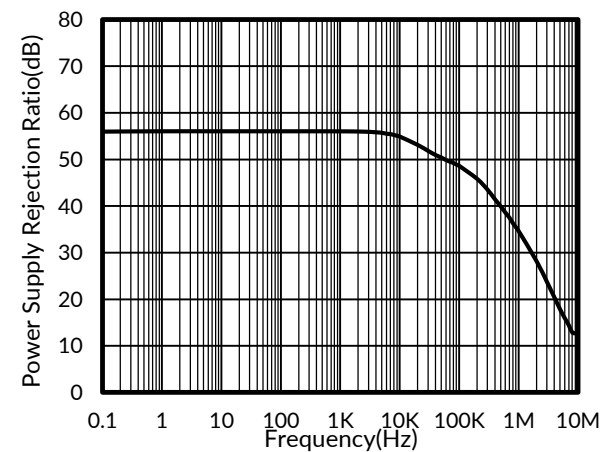

Figure 12. Power Supply Rejection Ratio vs Frequency

TYPICAL PERFORMANCE CHARACTERISTICS

NOTE: The graphs and tables provided following this note are a statistical summary based on a limited number of samples and are provided for informational purposes only.

$V_{IN} = V_{OUT (NOMINAL)} + 0.5V$, $C_{IN} = 1\mu F$, $C_{OUT} = 1\mu F$, $T_A = +25^\circ C$, unless otherwise noted.

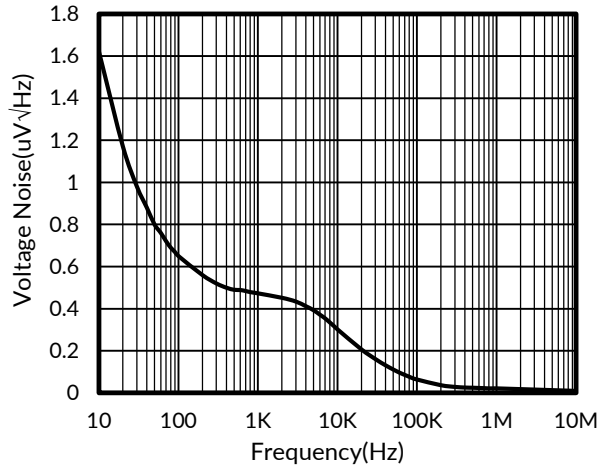
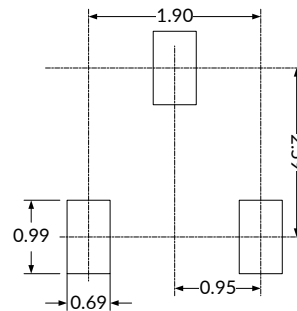
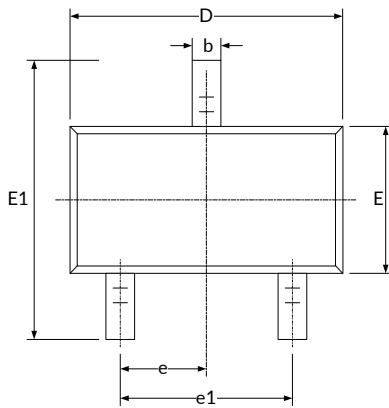

Figure 13. Output Voltage Noise vs Frequency

9 PACKAGE OUTLINE DIMENSIONS

SOT23-3⁽³⁾



RECOMMENDED LAND PATTERN (Unit: mm)

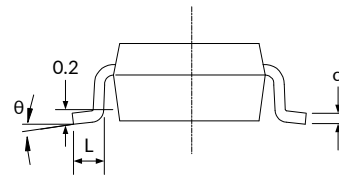
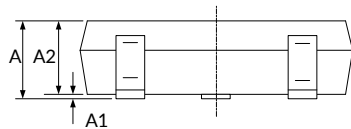

Symbol	Dimensions In Millimeters		Dimensions In Inches	
	Min	Max	Min	Max
A ⁽¹⁾	1.050	1.250	0.041	0.049
A1	0.000	0.100	0.000	0.004
A2	1.050	1.150	0.041	0.045
b	0.300	0.500	0.012	0.020
c	0.100	0.200	0.004	0.008
D ⁽¹⁾	2.820	3.020	0.111	0.119
E ⁽¹⁾	1.500	1.700	0.059	0.067
E1	2.650	2.950	0.104	0.116
e	0.950(BSC) ⁽²⁾		0.037(BSC) ⁽²⁾	
e1	1.800	2.000	0.071	0.079
L	0.300	0.600	0.012	0.024
θ	0°	8°	0°	8°

NOTE:

1. Plastic or metal protrusions of 0.15mm maximum per side are not included.
2. BSC (Basic Spacing between Centers), "Basic" spacing is nominal.
3. This drawing is subject to change without notice.

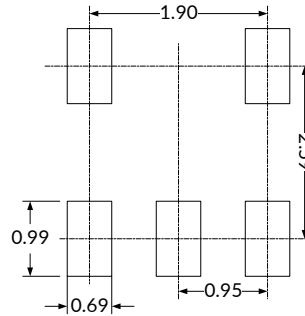
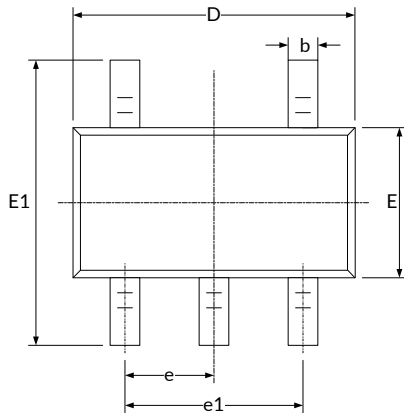
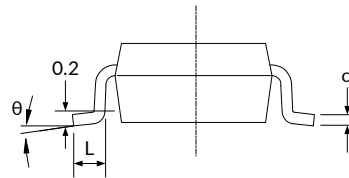
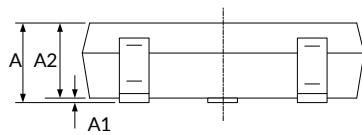
SOT23-5⁽³⁾

RECOMMENDED LAND PATTERN (Unit: mm)

Symbol	Dimensions In Millimeters		Dimensions In Inches	
	Min	Max	Min	Max
A ⁽¹⁾	1.050	1.250	0.041	0.049
A1	0.000	0.100	0.000	0.004
A2	1.050	1.150	0.041	0.045
b	0.300	0.500	0.012	0.020
c	0.100	0.200	0.004	0.008
D ⁽¹⁾	2.820	3.020	0.111	0.119
E ⁽¹⁾	1.500	1.700	0.059	0.067
E1	2.650	2.950	0.104	0.116
e	0.950(BSC) ⁽²⁾		0.037(BSC) ⁽²⁾	
e1	1.800	2.000	0.071	0.079
L	0.300	0.600	0.012	0.024
θ	0°	8°	0°	8°

NOTE:

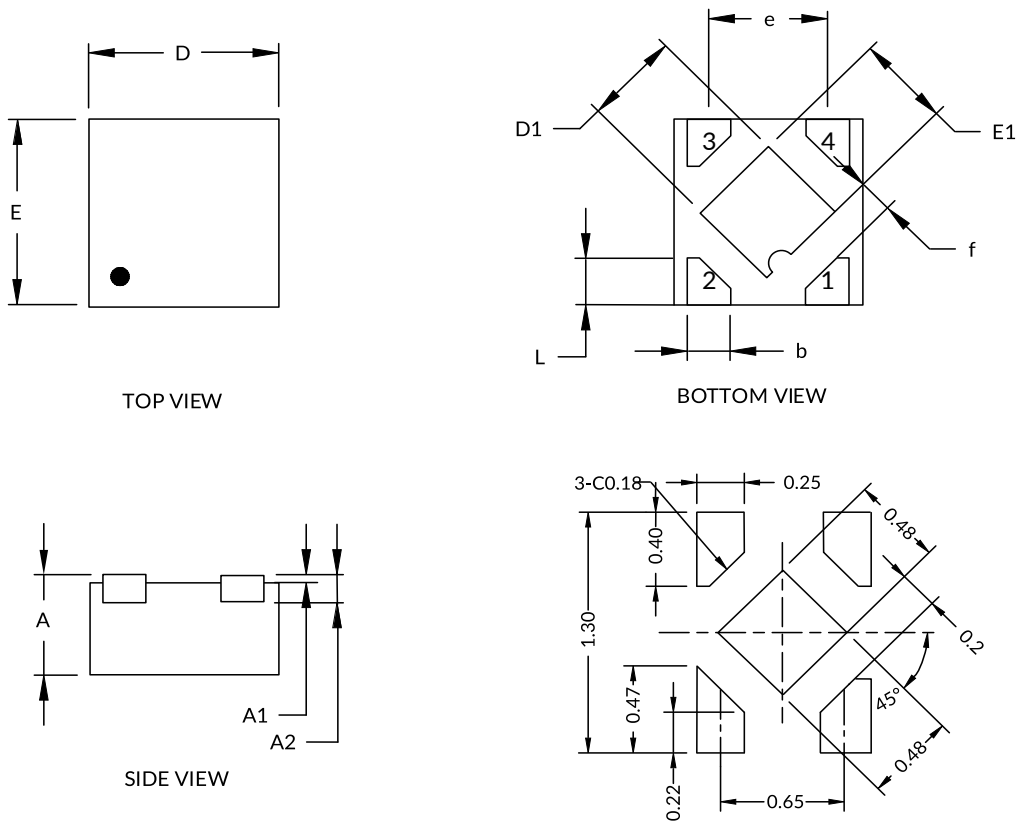
1. Plastic or metal protrusions of 0.15mm maximum per side are not included.
2. BSC (Basic Spacing between Centers), "Basic" spacing is nominal.
3. This drawing is subject to change without notice.

XDFN1X1-4⁽³⁾

RECOMMENDED LAND PATTERN (Unit: mm)

Symbol	Dimensions In Millimeters			Dimensions In Inches		
	MIN	TYP	MAX	MIN	TYP	MAX
A ⁽¹⁾	0.340	0.370	0.400	0.013	0.015	0.016
A1	0.000	0.020	0.050	0.000	0.001	0.002
A2	0.100 REF ⁽²⁾			0.004 REF ⁽²⁾		
D ⁽¹⁾	0.950	1.000	1.050	0.037	0.039	0.041
D1	0.430	0.480	0.530	0.017	0.019	0.021
E ⁽¹⁾	0.950	1.000	1.050	0.037	0.039	0.041
E1	0.430	0.480	0.530	0.017	0.019	0.021
b	0.170	0.220	0.270	0.007	0.009	0.011
e	0.600	0.650	0.700	0.024	0.026	0.028
f	0.195 REF ⁽²⁾			0.008 REF ⁽²⁾		
L	0.200	0.250	0.300	0.008	0.010	0.012

NOTE:

1. Plastic or metal protrusions of 0.075mm maximum per side are not included.
2. REF is the abbreviation for Reference.
3. This drawing is subject to change without notice.

10 TAPE AND REEL INFORMATION

REEL DIMENSIONS

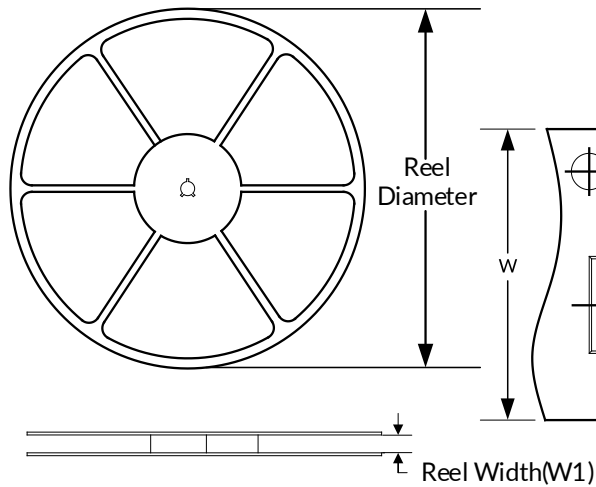

TAPE DIMENSION

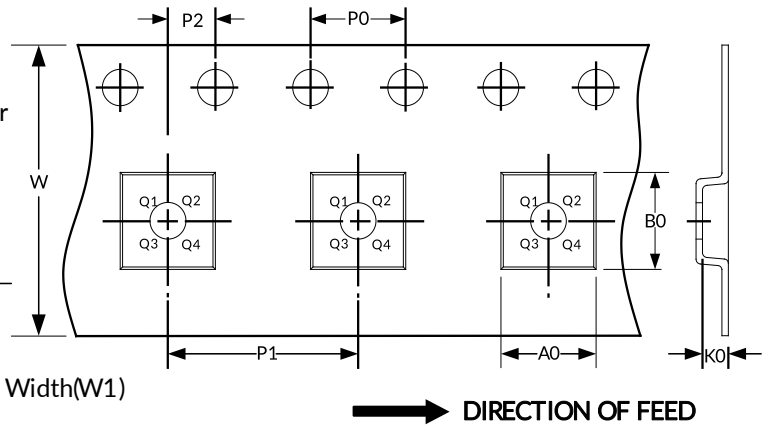

NOTE: The picture is only for reference. Please make the object as the standard.

KEY PARAMETER LIST OF TAPE AND REEL

Package Type	Reel Diameter	Reel Width(mm)	A0 (mm)	B0 (mm)	K0 (mm)	P0 (mm)	P1 (mm)	P2 (mm)	W (mm)	Pin1 Quadrant
XDFN1X1-4	7"	9.5	1.16	1.16	0.5	4.0	4.0	2.0	8.0	Q1
SOT23-5	7"	9.5	3.20	3.20	1.40	4.0	4.0	2.0	8.0	Q3
SOT23-3	7"	9.0	3.20	3.30	1.30	4.0	4.0	2.0	8.0	Q3

NOTE:

1. All dimensions are nominal.
2. Plastic or metal protrusions of 0.15mm maximum per side are not included.

IMPORTANT NOTICE AND DISCLAIMER

Jiangsu Runic Technology Co., Ltd. will accurately and reliably provide technical and reliability data (including data sheets), design resources (including reference designs), application or other design advice, WEB tools, safety information and other resources, without warranty of any defect, and will not make any express or implied warranty, including but not limited to the warranty of merchantability Implied warranty that it is suitable for a specific purpose or does not infringe the intellectual property rights of any third party.

These resources are intended for skilled developers designing with Runic products You will be solely responsible for: (1) Selecting the appropriate products for your application; (2) Designing, validating and testing your application; (3) Ensuring your application meets applicable standards and any other safety, security or other requirements; (4) Runic and the Runic logo are registered trademarks of Runic Incorporated. All trademarks are the property of their respective owners; (5) For change details, review the revision history included in any revised document. The resources are subject to change without notice. Our company will not be liable for the use of this product and the infringement of patents or third-party intellectual property rights due to its use.