

General-Purpose Low-Voltage Open-Drain Output Comparator

1 FEATURES

- **Supply Range: +1.8V to +5.5V**
- **Low Supply Current**
50µA (TYP) per channel at $V_S = 5V$
- **Input Common-Mode Voltage Range**
Includes Ground
- **Low Output Saturation Voltage 150mV**
Typical
- **Open-Drain Output for Maximum Flexibility**
- **SPECIFIED UP TO +125°C**
- **Micro SIZE PACKAGES: SOT23-5**

2 APPLICATIONS

- **Hysteresis Comparators**
- **Oscillators**
- **Window Comparators**
- **Industrial Equipment**
- **Test and Measurement**

3 DESCRIPTIONS

The RS331 and RS393 is the single and dual comparator version, the RS339 is quad comparator version, and both are open-drain output comparators for maximum flexibility. It can operate from 1.8V to 5.5V, and have low power consuming 50µA (TYP) per channel.

The RS331, RS393 and RS339 are the most cost-effective solutions for applications where low voltage operation, low power and space saving are the primary specifications in circuit design for portable consumer products.

The RS331, RS393 and RS339 are available in Green SOT23-5, SOP8, MSOP8, SOP14 and TSSOP14 packages. It operates over an ambient temperature range of -40°C to +125°C.

Device Information (1)

PART NUMBER	PACKAGE	BODY SIZE (NOM)
RS331	SOT23-5	1.60mm×2.92mm
RS393	SOP8	4.90mm×3.90mm
	MSOP8	3.00mm×3.00mm
RS339	SOP14	8.65mm×3.90mm
	TSSOP14	5.00mm×4.40mm

(1) For all available packages, see the orderable addendum at the end of the data sheet.

Table of Contents

1 FEATURES	1
2 APPLICATIONS	1
3 DESCRIPTIONS	1
4 Revision History	3
5 PACKAGE/ORDERING INFORMATION ⁽¹⁾	4
6 Pin Configuration and Functions (Top View)	5
7 SPECIFICATIONS	7
7.1 Absolute Maximum Ratings	7
7.2 ESD Ratings	7
7.3 Recommended Operating Conditions	7
7.4 ELECTRICAL CHARACTERISTICS(V _S =5.0V)	8
7.5 ELECTRICAL CHARACTERISTICS(V _S =2.7V)	9
7.6 ELECTRICAL CHARACTERISTICS(V _S =1.8V)	10
7.7 TYPICAL CHARACTERISTICS	11
8 Detailed Description	13
8.1 Overview	13
9 Application and Implementation	14
9.1 Application Information	14
9.2 Typical Application	14
9.3 Power Supply Recommendations	14
10 Layout	15
10.1 Layout Guidelines	15
10.2 Layout Example	15
11 PACKAGE OUTLINE DIMENSIONS	16
12 TAPE AND REEL INFORMATION	21

4 Revision History

Note: Page numbers for previous revisions may differ from page numbers in the current version.

VERSION	Change Date	Change Item
A.1	2019/05/29	RS331 Initial version completed
A.2	2019/07/04	Added SOIC-8 package for RS393
A.3	2019/07/06	Added SOIC-14 and TSSOP-14 packages for RS339
A.4	2020/11/25	Added MSOP-8 package for RS393 Change package quantity and operating temperature range
A.5	2022/01/25	1.Delete the second remark in the Absolute Maximum Ratings in page5 @A.4 Version 2.Change Functional Block Diagram 3.Added TAPE AND REEL INFORMATION
A.6	2022/07/22	Change Absolute Maximum Ratings NOTE on Page 5@RevA.5
A.7	2023/04/11	Update I _Q PARAMETER in ELECTRICAL CHARACTERISTICS
A.7.1	2024/02/23	Modify packaging naming

5 PACKAGE/ORDERING INFORMATION ⁽¹⁾

Orderable Device	Package Type	Pin	Channel	Op Temp(°C)	Device Marking ⁽²⁾	Package Qty
RS331XF	SOT23-5	5	1	-40°C ~+125°C	331	Tape and Reel,3000
RS393XK	SOP8	8	2	-40°C ~+125°C	RS393	Tape and Reel,4000
RS393XM	MSOP8	8	2	-40°C ~+125°C	RS393	Tape and Reel,4000
RS339XP	SOP14	14	4	-40°C ~+125°C	RS339	Tape and Reel, 4000
RS339XQ	TSSOP14	14	4	-40°C ~+125°C	RS339	Tape and Reel, 4000

NOTE:

- (1) This information is the most current data available for the designated devices. This data is subject to change without notice and revision of this document. For browser-based versions of this data sheet, refer to the right-hand navigation.
- (2) There may be additional marking, which relates to the lot trace code information(data code and vendor code), the logo or the environmental category on the device.

6 Pin Configuration and Functions (Top View)

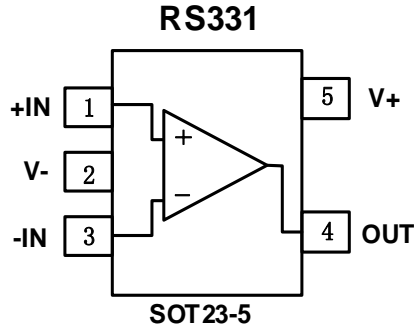

Pin Description

NAME	PIN	I/O ⁽¹⁾	DESCRIPTION
	SOT23-5		
+IN	1	I	Noninverting input
V-	2	P	Negative (lowest) power supply
-IN	3	I	Inverting input
OUT	4	O	Output
V+	5	P	Positive (highest) power supply

(1) I=Input, O=Output, P=Power

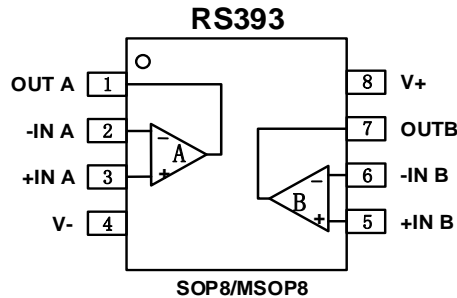

Pin Description

NAME	PIN	I/O ⁽¹⁾	DESCRIPTION
	SOP8/MSOP8		
OUTA	1	O	Output, channel A
-INA	2	I	Inverting input, channel A
+INA	3	I	Noninverting input, channel A
V-	4	P	Negative (lowest) power supply
+INB	5	I	Noninverting input, channel B
-INB	6	I	Inverting input, channel B
OUTB	7	O	Output, channel B
V+	8	P	Positive (highest) power supply

(1) I=Input, O=Output, P=Power

Pin Configuration and Functions (Top View)

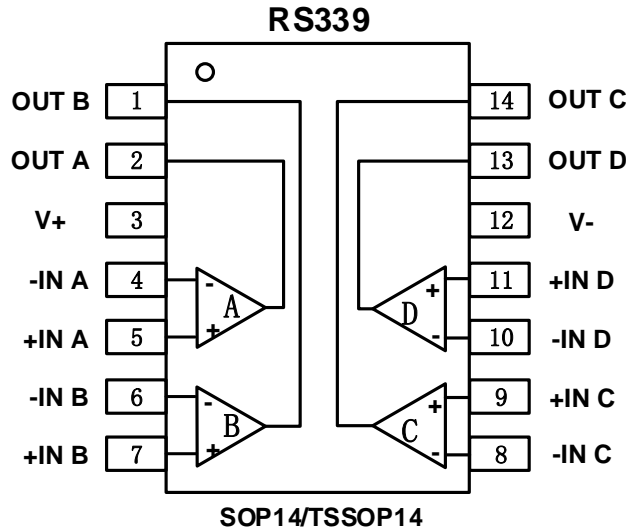

Pin Description

NAME	PIN	I/O ⁽¹⁾	DESCRIPTION
	SOP14/TSSOP14		
OUTB	1	O	Output, channel B
OUTA	2	O	Output, channel A
V+	3	P	Positive (highest) power supply
-INA	4	I	Inverting input, channel A
+INA	5	I	Noninverting input, channel A
-INB	6	I	Inverting input, channel B
+INB	7	I	Noninverting input, channel B
-INC	8	I	Inverting input, channel C
+INC	9	I	Noninverting input, channel C
-IND	10	I	Inverting input, channel D
+IND	11	I	Noninverting input, channel D
V-	12	P	Negative (lowest) power supply
OUTD	13	O	Output, channel D
OUTC	14	O	Output, channel C

(1) I=Input, O=Output, P=Power

7 SPECIFICATIONS

7.1 Absolute Maximum Ratings

Over operating free-air temperature range (unless otherwise noted) ⁽¹⁾

		MIN	MAX	UNIT
Voltage	Supply, $V_S=(V+) - (V-)$		7	V
	Input pin (IN+, IN-) ⁽²⁾	(V-)-0.3	(V+) +0.3	
	Signal output pin ⁽³⁾	(V-)-0.3	(V+) +0.3	
Current	Signal input pin (IN+, IN-) ⁽²⁾	-10	10	mA
	Signal output pin ⁽³⁾	-55	55	mA
	Output short-circuit ⁽⁴⁾	Continuous		
θ_{JA}	Package thermal impedance ⁽⁵⁾	SOT23-5	230	°C/W
		SOP8	110	
		MSOP8	165	
		SOP14	105	
		TSSOP14	90	
Temperature	Operating range, T_A	-40	125	°C
	Junction, T_J ⁽⁶⁾	-40	150	
	Storage, T_{stg}	-65	150	

(1) Stresses above these ratings may cause permanent damage. Exposure to absolute maximum conditions for extended periods may degrade device reliability. These are stress ratings only, and functional operation of the device at these or any other conditions beyond those specified is not implied.

(2) Input signals that can swing more than 0.3V beyond the supply rails should be current-limited to ± 10 mA or less.

(3) Output signals that can swing more than 0.3V beyond the supply rails should be current-limited to ± 55 mA or less.

(4) Short-circuit from output to V_{CC} can cause excessive heating and eventual destruction.

(5) The package thermal impedance is calculated in accordance with JESD-51.

(6) The maximum power dissipation is a function of $T_{J(MAX)}$, $R_{\theta JA}$, and T_A . The maximum allowable power dissipation at any ambient temperature is $P_D = (T_{J(MAX)} - T_A) / R_{\theta JA}$. All numbers apply for packages soldered directly onto a PCB.

7.2 ESD Ratings

The following ESD information is provided for handling of ESD-sensitive devices in an ESD protected area only.

			VALUE	UNIT
$V_{(ESD)}$	Electrostatic discharge	Human-body model (HBM), per ANSI/ESDA/JEDEC JS-001, all pins ⁽¹⁾	± 2000	V
		Charged device model (CDM), per JEDEC specification JESD22-C101, all pins ⁽²⁾	± 1000	

(1) JEDEC document JEP155 states that 500V HBM allows safe manufacturing with a standard ESD control process.

(2) JEDEC document JEP157 states that 250V CDM allows safe manufacturing with a standard ESD control process.



ESD SENSITIVITY CAUTION

ESD damage can range from subtle performance degradation to complete device failure. Precision integrated circuits may be more susceptible to damage because very small parametric changes could cause the device not to meet its published specifications.

7.3 Recommended Operating Conditions

Over operating free-air temperature range (unless otherwise noted)

		MIN	NOM	MAX	UNIT
Supply voltage, $V_S=(V+) - (V-)$	Single-supply	1.8		5.5	V
	Dual-supply	± 0.9		± 2.75	

7.4 ELECTRICAL CHARACTERISTICS(V_S=5.0V)

(At T_A = +25°C, V_{CM}=V_S/2, unless otherwise noted.)

PARAMETER		CONDITIONS	RS331/RS393/RS339			
			MIN	TYP	MAX	UINTS
POWER SUPPLY						
V _S	Operating Voltage Range		1.8		5.5	V
I _Q	Quiescent Current/Per Channel			50	150	μA
PSRR	Power-Supply Rejection Ratio	V _S =1.8V to 5.5V, V _{CM} =(V)+0.5V		70		dB
INPUT						
V _{OS}	Input Offset Voltage		-3.5	±0.6	3.5	mV
ΔV _{OS} /ΔT	Input Offset Voltage Drift	V _{CM} =V _S /2, -40°C ≤ T _A ≤ 125°C		±0.5		μV/°C
I _B	Input Bias Current			±1	±10	pA
I _{OS}	Input Offset Current			±1	±10	pA
V _{CM}	Common-Mode Voltage Range	T _A = -40°C to 125°C	(V _S)-0.1		(V _S)+0.1	V
CMRR	Common-Mode Rejection Ratio	V _{CM} = -0.1 to 5.6V		70		dB
OUTPUT						
V _{SAT}	Saturation Voltage	I _O ≤ 4mA		150	350	mV
V _{OH}	Output Pull-up Voltage Range				5.6	V
I _O	Output Current(Sinking)	V _O ≤ 1.5V		27		mA
I _{LEAK}	Output Leakage Current			0.01	10	nA
SWITCHING						
T _{PHL}	Propagation Delay H To L	R _{PU} =5.1KΩ, Overdrive = 10mV		205		ns
		R _{PU} =5.1KΩ, Overdrive = 100mV		185		
T _{PLH}	Propagation Delay L To H	R _{PU} =5.1KΩ, Overdrive = 10mV		660		
		R _{PU} =5.1KΩ, Overdrive = 100mV		700		
T _F	Fall Time	R _{PU} =5.1KΩ, Overdrive = 100mV		42		ns

7.5 ELECTRICAL CHARACTERISTICS(V_S=2.7V)

(At T_A = +25°C, V_{CM}=V_S/2, unless otherwise noted.)

PARAMETER		CONDITIONS	RS331/RS393/RS339			
			MIN	TYP	MAX	UINTS
POWER SUPPLY						
V _S	Operating Voltage Range		1.8		5.5	V
I _Q	Quiescent Current/Per Channel			48	140	μA
PSRR	Power-Supply Rejection Ratio	V _S =1.8V to 5.5V, V _{CM} =(V)+0.5V		70		dB
INPUT						
V _{OS}	Input Offset Voltage		-3.5	±0.6	3.5	mV
ΔV _{OS} /ΔT	Input Offset Voltage Drift	V _{CM} =V _S /2, -40°C ≤ T _A ≤125°C		±0.5		μV/°C
I _B	Input Bias Current			±1	±10	pA
I _{OS}	Input Offset Current			±1	±10	pA
V _{CM}	Common-Mode Voltage Range	T _A = -40°C to 125°C	(V ₋)-0.1		(V ₊)+0.1	V
CMRR	Common-Mode Rejection Ratio	V _{CM} = -0.1 to 2.8V		70		dB
OUTPUT						
V _{SAT}	Saturation Voltage	I _O ≤2.2mA		144		mV
V _{OH}	Output Pull-up Voltage Range				5.6	V
I _O	Output Current(Sinking)	V _O ≤1.5V		13		mA
I _{LEAK}	Output Leakage Current			0.01	10	nA
SWITCHING						
T _{PHL}	Propagation Delay H To L	R _{PU} =5.1KΩ, Overdrive =10mV		250		ns
		R _{PU} =5.1KΩ, Overdrive=100mV		230		
T _{PLH}	Propagation Delay L To H	R _{PU} =5.1KΩ, Overdrive =10mV		680		
		R _{PU} =5.1KΩ, Overdrive=100mV		702		
T _F	Fall Time	R _{PU} =5.1KΩ, Overdrive=100mV		52		ns

7.6 ELECTRICAL CHARACTERISTICS(V_S=1.8V)

(At T_A = +25°C, V_{CM}=V_S/2, unless otherwise noted.)

PARAMETER		CONDITIONS	RS331/RS393/RS339			
			MIN	TYP	MAX	UINTS
POWER SUPPLY						
V _S	Operating Voltage Range		1.8		5.5	V
I _Q	Quiescent Current/Per Channel			40	135	μA
PSRR	Power-Supply Rejection Ratio	V _S =1.8V to 5.5V, V _{CM} =(V)+0.5V		70		dB
INPUT						
V _{OS}	Input Offset Voltage		-3.5	±0.6	3.5	mV
ΔV _{OS} /ΔT	Input Offset Voltage Drift	V _{CM} =V _S /2, -40°C ≤ T _A ≤125°C		±0.5		μV/°C
I _B	Input Bias Current			±1	±10	pA
I _{OS}	Input Offset Current			±1	±10	pA
V _{CM}	Common-Mode Voltage Range	T _A = -40°C to 125°C	(V ₋)-0.1		(V ₊)+0.1	V
CMRR	Common-Mode Rejection Ratio	V _{CM} = -0.1 to 1.9V		70		dB
OUTPUT						
V _{SAT}	Saturation Voltage	I _O ≤1.5mA		144		mV
V _{OH}	Output Pull-up Voltage Range				5.6	V
I _O	Output Current(Sinking)	V _O ≤0.8V		5		mA
I _{LEAK}	Output Leakage Current			0.01	10	nA
SWITCHING						
T _{PHL}	Propagation Delay H To L	R _{PU} =5.1KΩ, Overdrive =10mV		272		ns
		R _{PU} =5.1KΩ, Overdrive=100mV		270		
T _{PLH}	Propagation Delay L To H	R _{PU} =5.1KΩ, Overdrive =10mV		712		
		R _{PU} =5.1KΩ, Overdrive=100mV		706		
T _F	Fall Time	R _{PU} =5.1KΩ, Overdrive=100mV		110		ns

7.7 TYPICAL CHARACTERISTICS

NOTE: The graphs and tables provided following this note are a statistical summary based on a limited number of samples and are provided for informational purposes only.

At $T_A = +25^\circ\text{C}$, $V_S=5\text{V}$, $V_{CM} = V_S/2$, $C_L=15\text{pF}$ unless otherwise noted.

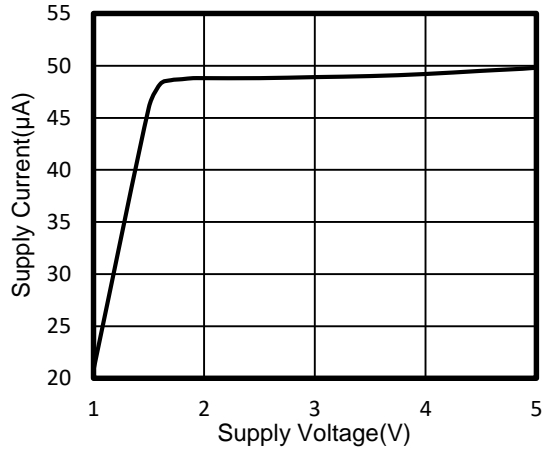

Figure 1. Supply Current vs Supply Voltage Output High

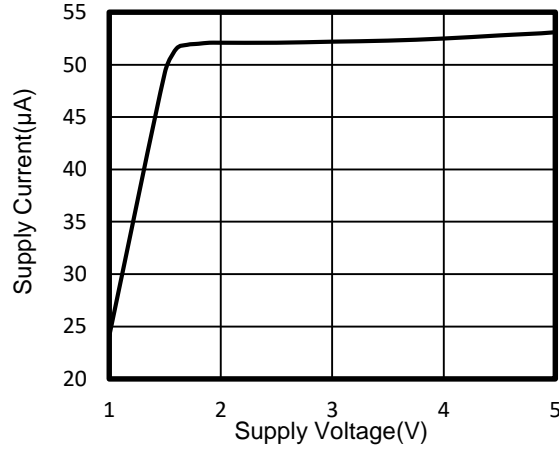

Figure 2. Supply Current vs Supply Voltage Output Low

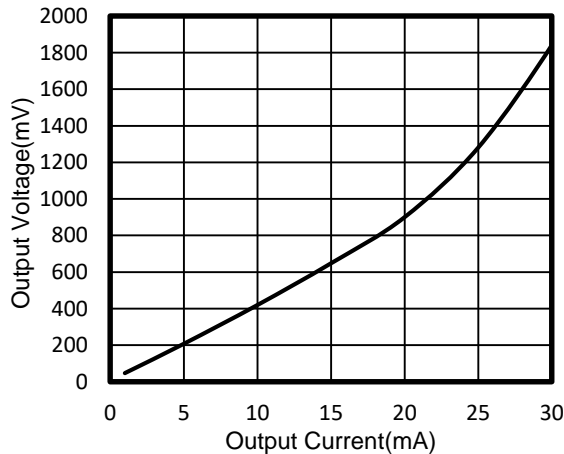

Figure 3. Output Voltage vs Output Current

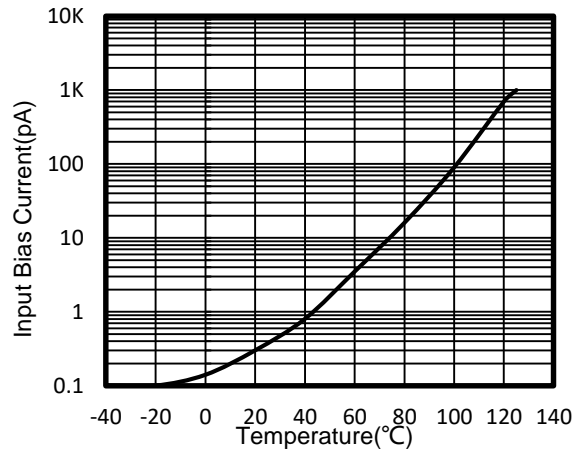

Figure 4. INPUT BIAS CURRENT vs TEMPERATURE

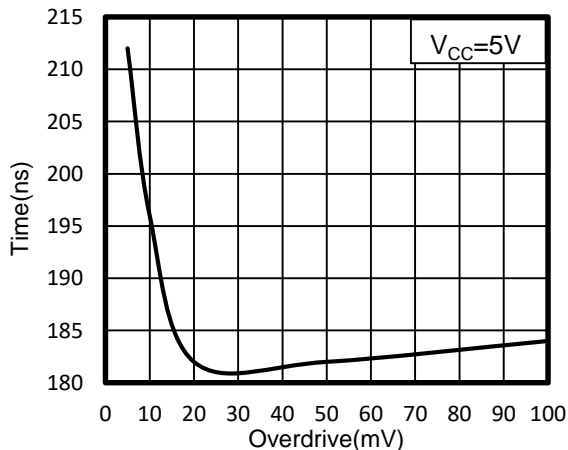

Figure 5. Response Time vs Input Overdrives Negative Transition

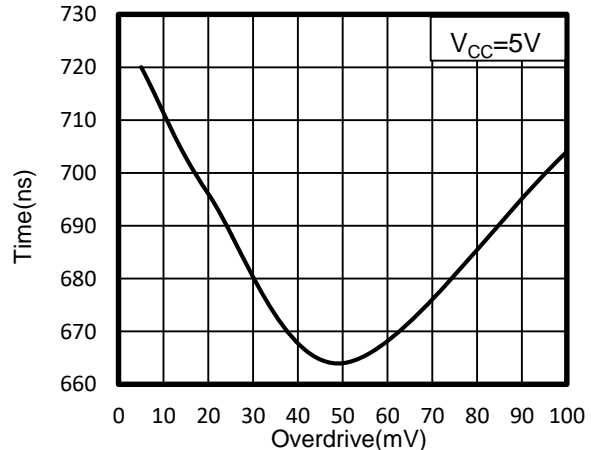

Figure 6. Response Time vs Input Overdrives Positive Transition

TYPICAL CHARACTERISTICS

NOTE: The graphs and tables provided following this note are a statistical summary based on a limited number of samples and are provided for informational purposes only.

At $T_A = +25^\circ\text{C}$, $V_S=5\text{V}$, $V_{CM} = V_S/2$, $C_L=15\text{pF}$ unless otherwise noted.

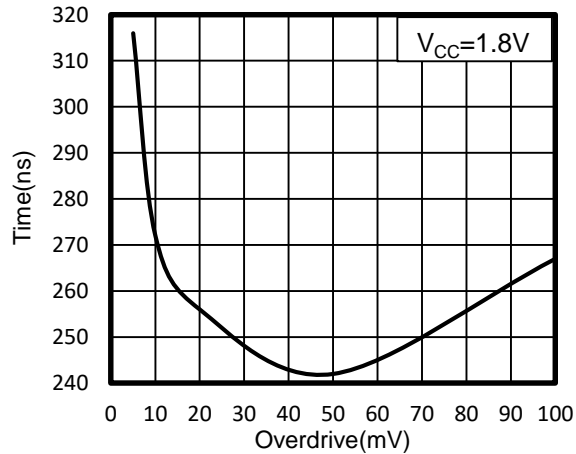

Figure 7. Response Time vs Input Overdrives Negative Transition

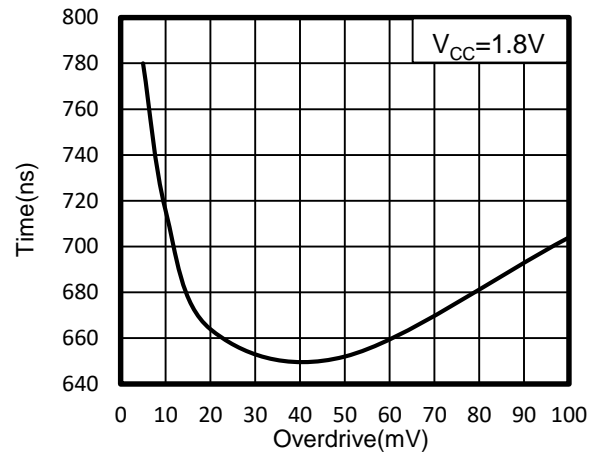

Figure 8. Response Time vs Input Overdrives Positive Transition

8 Detailed Description

8.1 Overview

The RS331, RS393 and RS339 family of comparators can operate up to 5.5V on the supply pin. This standard device has proven ubiquity and versatility across a wide range of applications. This is due to its low power and high speed. The open-drain output allows the user to configure the output's logic low voltage (V_{OL}) and can be utilized to enable the comparator to be used in AND functionality.

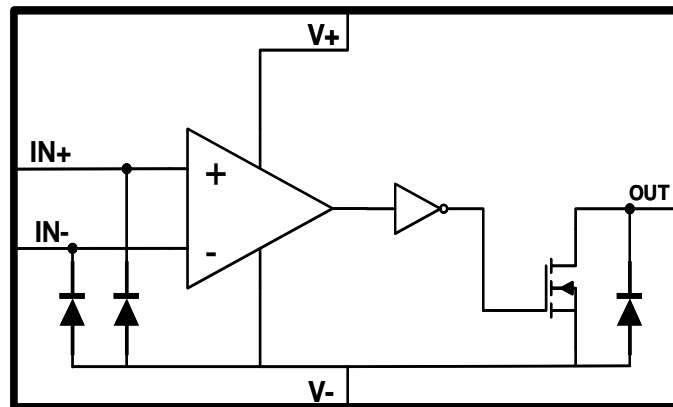

Figure 9. Functional Block Diagram

9 Application and Implementation

Information in the following applications sections is not part of the Runic component specification, and Runic does not warrant its accuracy or completeness. Runic's customers are responsible for determining suitability of components for their purposes. Customers should validate and test their design implementation to confirm system functionality.

9.1 Application Information

RS331, RS393 and RS339 will typically be used to compare a single signal to a reference or two signals against each other. Many users take advantage of the open drain output (logic high with pull-up) to drive the comparison logic output to a logic voltage level to an MCU or logic device.

9.2 Typical Application

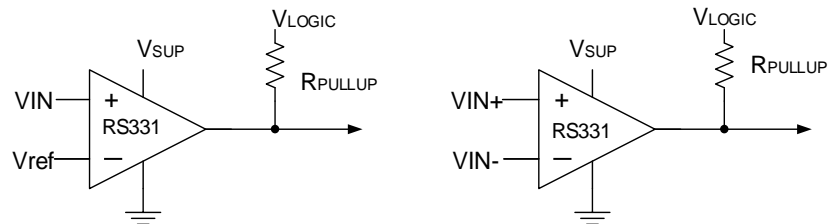

Figure 10. Typical Application Schematic

9.3 Power Supply Recommendations

For fast response and comparison applications with noisy or AC inputs, it is recommended to use a bypass capacitor on the supply pin to reject any variation on the supply voltage. This variation causes temporary fluctuations in the comparator's input common mode range and create an inaccurate comparison.

10 Layout

10.1 Layout Guidelines

For accurate comparator applications without hysteresis it is important maintain a stable power supply with minimized noise and glitches, which can affect the high-level input common mode voltage range. In order to achieve this, it is best to add a bypass capacitor between the supply voltage and ground. This should be implemented on the positive power supply and negative supply (if available). If a negative supply is not being used, do not put a capacitor between the IC's GND pin and system ground.

10.2 Layout Example

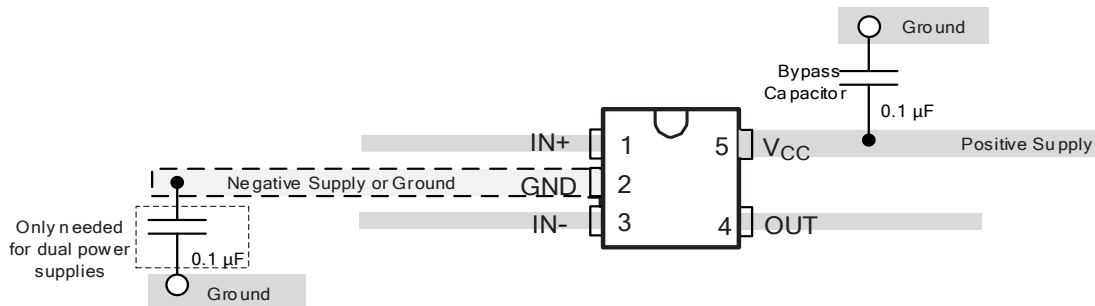
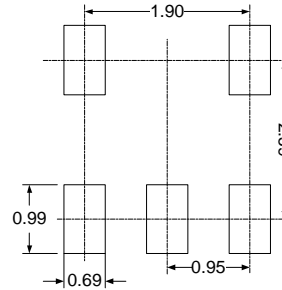
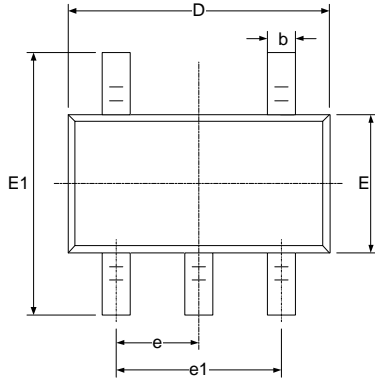

Figure 11. RS331 Layout Example

11 PACKAGE OUTLINE DIMENSIONS

SOT23-5



RECOMMENDED LAND PATTERN (Unit: mm)

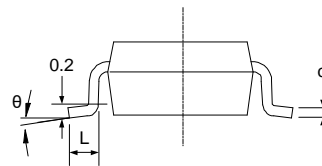
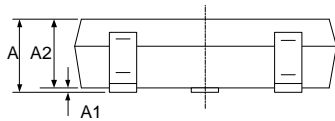

Symbol	Dimensions In Millimeters		Dimensions In Inches	
	Min	Max	Min	Max
A	1.050	1.250	0.041	0.049
A1	0.000	0.100	0.000	0.004
A2	1.050	1.150	0.041	0.045
b	0.300	0.500	0.012	0.020
c	0.100	0.200	0.004	0.008
D	2.820	3.020	0.111	0.119
E	1.500	1.700	0.059	0.067
E1	2.650	2.950	0.104	0.116
e	0.950(BSC)		0.037(BSC)	
e1	1.800	2.000	0.071	0.079
L	0.300	0.600	0.012	0.024
θ	0°	8°	0°	8°

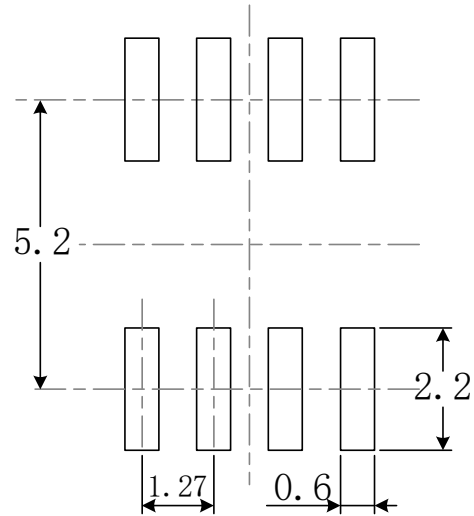
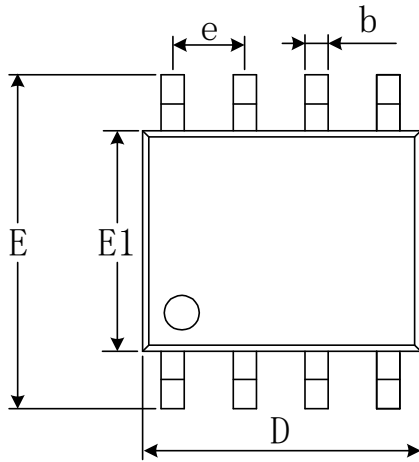
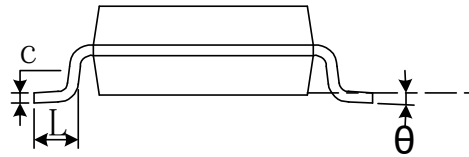
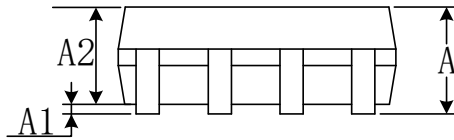
SOP8

RECOMMENDED LAND PATTERN (Unit: mm)

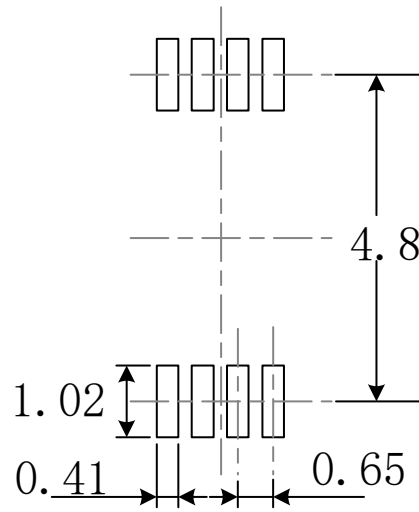
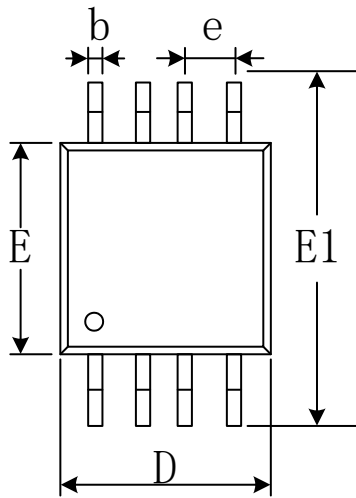
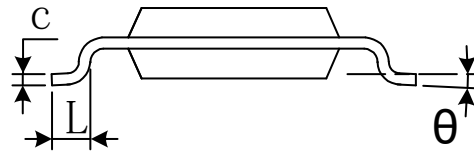
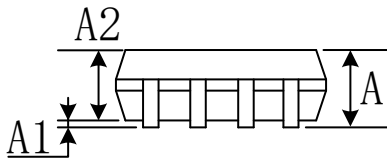
Symbol	Dimensions In Millimeters		Dimensions In Inches	
	Min	Max	Min	Max
A	1.350	1.750	0.053	0.069
A1	0.100	0.250	0.004	0.010
A2	1.350	1.550	0.053	0.061
b	0.330	0.510	0.013	0.020
c	0.170	0.250	0.007	0.010
D	4.800	5.000	0.189	0.197
e	1.270(BSC)		0.050(BSC)	
E	5.800	6.200	0.228	0.244
E1	3.800	4.000	0.150	0.157
L	0.400	1.270	0.016	0.050
θ	0°	8°	0°	8°

MSOP8

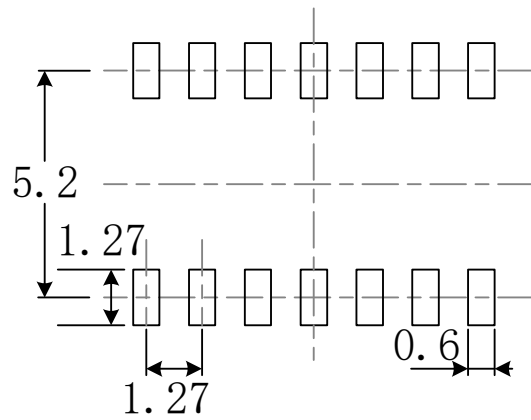
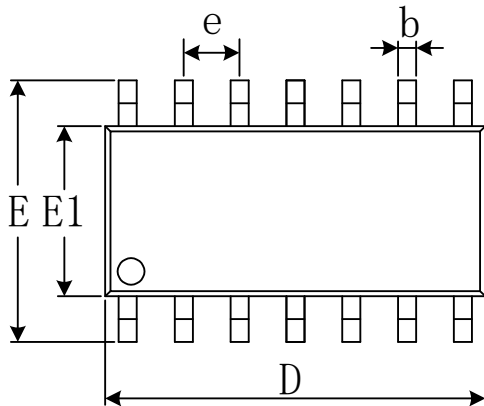
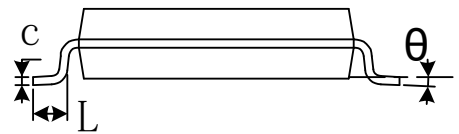
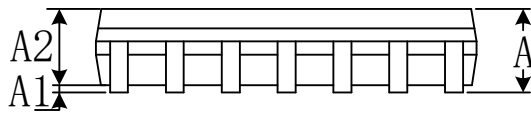
RECOMMENDED LAND PATTERN (Unit: mm)

Symbol	Dimensions In Millimeters		Dimensions In Inches	
	Min	Max	Min	Max
A	0.820	1.100	0.032	0.043
A1	0.020	0.150	0.001	0.006
A2	0.750	0.950	0.030	0.037
b	0.250	0.380	0.010	0.015
c	0.090	0.230	0.004	0.009
D	2.900	3.100	0.114	0.122
e	0.650(BSC)		0.026(BSC)	
E	2.900	3.100	0.114	0.122
E1	4.750	5.050	0.187	0.199
L	0.400	0.800	0.016	0.031
θ	0°	6°	0°	6°

SOP14

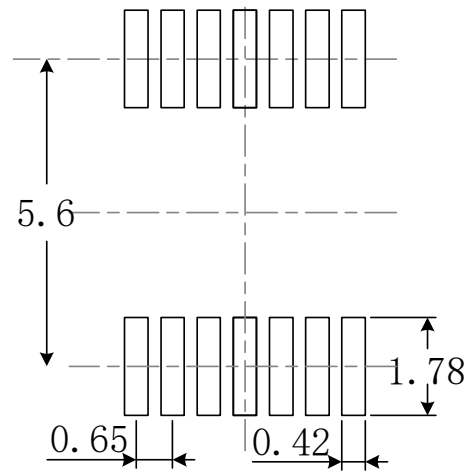
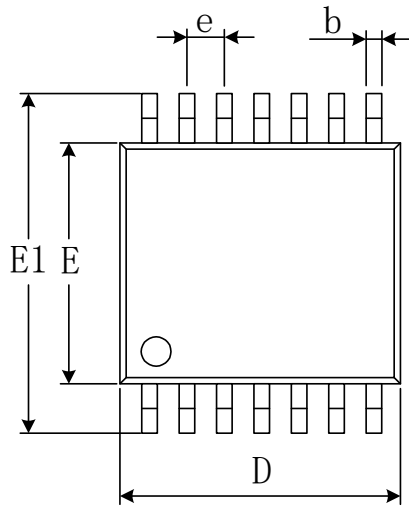
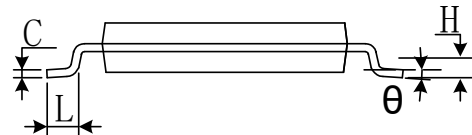
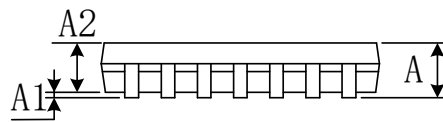
RECOMMENDED LAND PATTERN (Unit: mm)

Symbol	Dimensions In Millimeters		Dimensions In Inches	
	Min	Max	Min	Max
A	1.350	1.750	0.053	0.069
A1	0.100	0.250	0.004	0.010
A2	1.350	1.550	0.053	0.061
b	0.310	0.510	0.012	0.020
c	0.100	0.250	0.004	0.010
D	8.450	8.850	0.333	0.348
e	1.270(BSC)		0.050(BSC)	
E	5.800	6.200	0.228	0.244
E1	3.800	4.000	0.150	0.157
L	0.400	1.270	0.016	0.050
θ	0°	8°	0°	8°

TSSOP14

RECOMMENDED LAND PATTERN (Unit: mm)

Symbol	Dimensions In Millimeters		Dimensions In Inches	
	Min	Max	Min	Max
A		1.200		0.047
A1	0.050	0.150	0.002	0.006
A2	0.800	1.050	0.031	0.041
b	0.190	0.300	0.007	0.012
c	0.090	0.200	0.004	0.008
D	4.860	5.100	0.191	0.201
E	4.300	4.500	0.169	0.177
E1	6.250	6.550	0.246	0.258
e	0.650(BSC)		0.026(BSC)	
L	0.500	0.700	0.020	0.028
H	0.25(TYP)		0.01(TYP)	
θ	1°	7°	1°	7°

NOTE:

- A. All linear dimension is in millimeters.
- B. This drawing is subject to change without notice.
- C. Body dimensions do not include mold flash or protrusion. Mold flash and protrusion shall not exceed 0.15 per side.
- D. BSC: Basic Dimension. Theoretically exact value shown without tolerances.

12 TAPE AND REEL INFORMATION

REEL DIMENSIONS

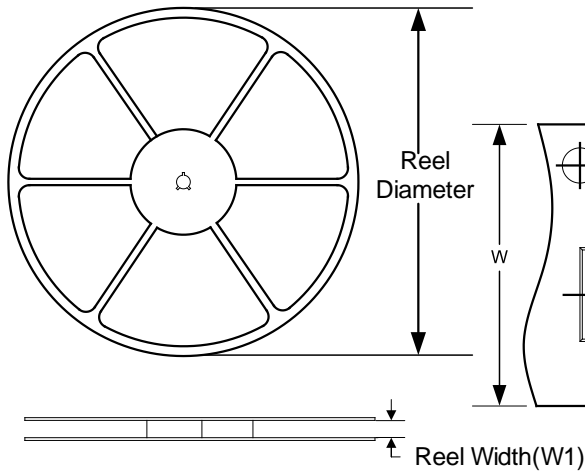

TAPE DIMENSION

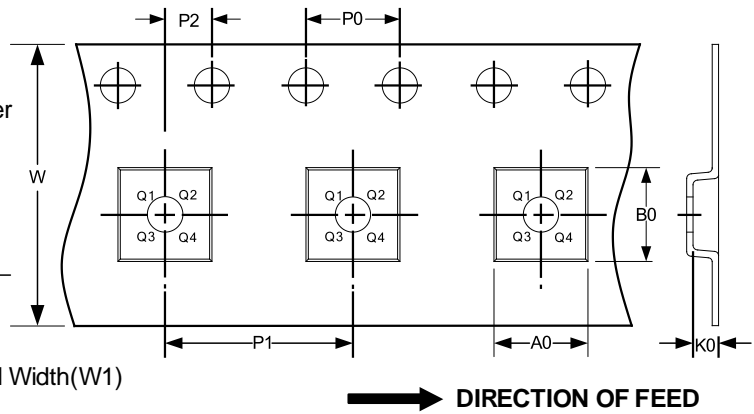

NOTE: The picture is only for reference. Please make the object as the standard.

KEY PARAMETER LIST OF TAPE AND REEL

Package Type	Reel Diameter	Reel Width(mm)	A0 (mm)	B0 (mm)	K0 (mm)	P0 (mm)	P1 (mm)	P2 (mm)	W (mm)	Pin1 Quadrant
SOT23-5	7"	9.5	3.20	3.20	1.40	4.0	4.0	2.0	8.0	Q3
SOP8	13"	12.4	6.40	5.40	2.10	4.0	8.0	2.0	12.0	Q1
MSOP8	13"	12.4	5.20	3.30	1.50	4.0	8.0	2.0	12.0	Q1
SOP14	13"	16.4	6.60	9.30	2.10	4.0	8.0	2.0	16.0	Q1
TSSOP14	13"	12.4	6.95	5.60	1.20	4.0	8.0	2.0	12.0	Q1

NOTE:

1. All dimensions are nominal.
2. Plastic or metal protrusions of 0.15mm maximum per side are not included.

IMPORTANT NOTICE AND DISCLAIMER

Jiangsu Runic Technology Co., Ltd. will accurately and reliably provide technical and reliability data (including data sheets), design resources (including reference designs), application or other design advice, WEB tools, safety information and other resources, without warranty of any defect, and will not make any express or implied warranty, including but not limited to the warranty of merchantability Implied warranty that it is suitable for a specific purpose or does not infringe the intellectual property rights of any third party.

These resources are intended for skilled developers designing with Runic products You will be solely responsible for: (1) Selecting the appropriate products for your application; (2) Designing, validating and testing your application; (3) Ensuring your application meets applicable standards and any other safety, security or other requirements; (4) Runic and the Runic logo are registered trademarks of Runic Incorporated. All trademarks are the property of their respective owners; (5) For change details, review the revision history included in any revised document. The resources are subject to change without notice. Our company will not be liable for the use of this product and the infringement of patents or third-party intellectual property rights due to its use.