

RS2G17 Dual Schmitt-Trigger buffer

FEATURES

- **Operating Voltage Range:**1.65V to 5.5V
- **Low Power Consumption:**1 μ A (Max)
- **Operating Temperature Range:**
-40°C to +125°C
- **Input Accept Voltage to 5.5V**
- **High Output Drive:** \pm 24mA at V_{CC} =3.0V
- **I_{off} Supports Partial-Power-Down Mode Operation**
- **Micro SIZE PACKAGES:** SOT23-6, SC70-6

APPLICATIONS

- AC Receiver and
- Home Theaters
- Blu-ray Players and Home Theaters
- Desktops or Notebook PCs
- Digital Video Cameras (DVC)
- Mobile Phones
- Personal Navigation Device (GPS)
- Portable Media Player

Functional Block Diagram

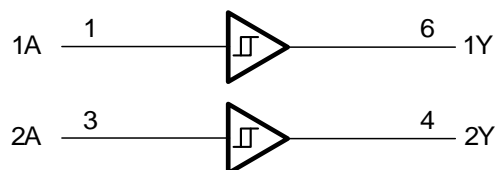

DESCRIPTION

The RS2G17 Dual Schmitt-trigger buffer is designed for 1.65V to 5.5V V_{CC} operation.

The RS2G17 device contains two buffer and performs the Boolean function $Y=A$. The device functions as two independent buffers with Schmitt-trigger inputs, so the device has different input threshold levels for positive-going (V_{T+}) and negative going (V_{T-}) signals to provide hysteresis(ΔV_T) which makes the device tolerant to slow or noisy input signals.

This device is fully specified for partial-power-down applications using I_{off} . The I_{off} circuitry disables the outputs, preventing damaging current backflow through the device when it is powered down.

The RS2G17 is available in Green SOT23-6 and SC70-6 packages. It operates over an ambient temperature range of -40°C to +125°C.

Device Information (1)

PART NUMBER	PACKAGE	BODY SIZE (NOM)
RS2G17	SOT23-6(6)	2.92mm \times 1.60mm
	SC70-6(6)	2.10mm \times 1.25mm

(1) For all available packages, see the orderable addendum at the end of the data sheet.

FUNCTION TABLE

INPUT	OUTPUT
A	Y
H	H
L	L

$Y=A$

H=High Voltage Level

L=Low Voltage Level

Revision History

Note: Page numbers for previous revisions may differ from page numbers in the current version.

Version	Change Date	Change Item
A.1	2021/1/26	initial version completed

PIN CONFIGURATIONS

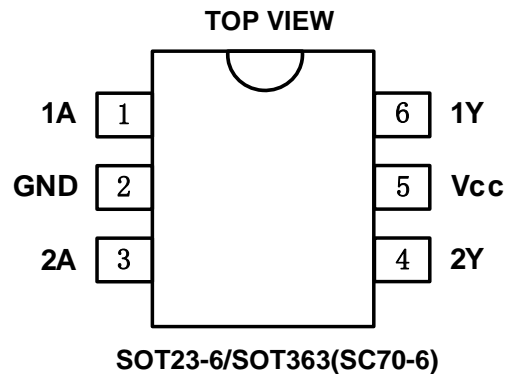

PIN DESCRIPTION

PIN	NAME	I/O TYPE	FUNCTION
SOT23-6/SOT363(SC70-6)			
1	1A	I	Input 1
2	GND	P	Ground
3	2A	I	Input 2
4	2Y	O	Output 2
5	V _{CC}	P	Power Pin
6	1Y	O	Output 1

Specifications

Absolute Maximum Ratings ⁽¹⁾

over operating free-air temperature range (unless otherwise noted) ⁽¹⁾⁽²⁾

		MIN	MAX	UNIT
V _{CC}	Supply voltage range	-0.5	6.5	V
V _I	Input voltage range ⁽²⁾	-0.5	6.5	V
V _O	Voltage range applied to any output in the high-impedance or power-off state ⁽²⁾	-0.5	6.5	V
V _O	Voltage range applied to any output in the high or low state ⁽²⁾⁽³⁾	-0.5	V _{CC} +0.5	V
I _{IK}	Input clamp current	V _I <0	-50	mA
I _{OK}	Output clamp current	V _O <0	-50	mA
I _O	Continuous output current		±50	mA
Continuous current through V _{CC} or GND			±100	mA
T _J	Junction temperature		150	°C
T _{stg}	Storage temperature	-65	150	°C

(1) Stresses beyond those listed under *Absolute Maximum Ratings* may cause permanent damage to the device. These are stress ratings only, and functional operation of the device at these or any other conditions beyond those indicated under *Recommended Operating Conditions* is not implied. Exposure to absolute-maximum-rated conditions for extended periods may affect device reliability.

(2) The input and output negative-voltage ratings may be exceeded if the input and output current ratings are observed.

(3) The value of V_{CC} is provided in the *Recommended Operating Conditions table*.

ESD Ratings

		VALUE	UNIT	
V _(ESD)	Electrostatic discharge	Human-body model (HBM)	±8000	V
		Machine model (MM)	±500	V

Thermal Information:

THERMAL METRIC		RS2G17		UNIT
		6PINS		
		SOT23-6	SOT363/(SC70-6)	
R _{θJA}	Junction-to-ambient thermal resistance	273.8	214.7	°C/W
R _{θJC(top)}	Junction-to-case(top) thermal resistance	126.8	127.1	°C/W
R _{θJB}	Junction-to-board thermal resistance	85.9	60.0	°C/W
Ψ _{JT}	Junction-to-top characterization parameter	10.9	33.4	°C/W
Ψ _{JB}	Junction-to-board characterization parameter	84.9	59.8	°C/W
R _{θJC(bot)}	Junction-to-case(bottom) thermal resistance	N/A	N/A	°C/W

PACKAGE/ORDERING INFORMATION

PRODUCT	ORDERING NUMBER	TEMPERATURE RANGE	PACKAGE LEAD	PACKAGE MARKING ^(1/2)	PACKAGE OPTION
RS2G17	RS2G17XF6	-40°C ~+125°C	SOT23-6	2G17	Tape and Reel,3000
	RS2G17XC6	-40°C ~+125°C	SC70-6(SOT363)	2G17 <u>X</u>	Tape and Reel,3000

NOTE:

- (1) There may be additional marking, which relates to the lot trace code information(data code and vendor code), the logo or the environmental category on the device.
- (2) X = Date Code

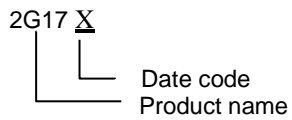
MARKING INFORMATION

ELECTRICAL CHARACTERISTICS

over recommended operating free-air temperature range (Full=-40°C to +125°C, typical values are at $T_A = +25^\circ\text{C}$, unless otherwise noted.) ⁽¹⁾

Recommended Operating Conditions

PARAMETER	SYMBOL	TEST CONDITIONS	MIN	MAX	UNIT
Supply voltage	V_{CC}	Operating	1.65	5.5	V
		Data retention only	1.5		
Input voltage	V_I		0	5.5	V
Output voltage	V_O		0	V_{CC}	V
Operating temperature	T_A		-40	+125	°C

DC Characteristics

PARAMETER		TEST CONDITIONS	V_{CC}	TEMP	MIN	TYP	MAX	UNIT
V_{T+}	Positive going input threshold voltage		1.65V	Full	0.75		1.05	V
			2.3V		1.25	1.55		
			3V		1.5	2.1		
			4.5V		2.3	3.0		
			5.5V		2.8	3.4		
V_{T-}	Negative going input threshold voltage		1.65V	Full	0.3		0.6	V
			2.3V		0.35	0.65		
			3V		0.45	0.75		
			4.5V		0.7	1.0		
			5.5V		0.85	1.15		
ΔV_T	Hysteresis ($V_{T+} - V_{T-}$)		1.65V	Full	0.35		0.6	V
			2.3V		0.6	1.2		
			3V		1.05	1.65		
			4.5V		1.6	2.0		
			5.5V		1.95	2.25		
V_{OH}		$I_{OH} = -100\mu\text{A}$	1.65V to 5.5V	Full	$V_{CC} - 0.1$			V
		$I_{OH} = -4\text{mA}$	1.65V		1.2			
		$I_{OH} = -8\text{mA}$	2.3V		1.9			
		$I_{OH} = -16\text{mA}$	3V		2.4			
		$I_{OH} = -24\text{mA}$			2.3			
		$I_{OH} = -32\text{mA}$	4.5V		3.8			
V_{OL}		$I_{OL} = 100\mu\text{A}$	1.65V to 5.5V	Full			0.1	V
		$I_{OL} = 4\text{mA}$	1.65V			0.45		
		$I_{OL} = 8\text{mA}$	2.3V			0.3		
		$I_{OL} = 16\text{mA}$	3V			0.4		
		$I_{OL} = 24\text{mA}$			0.55			
		$I_{OL} = 32\text{mA}$	4.5V		0.55			
I_I	A input	$V_I = 5.5\text{V}$ or GND	0V to 5.5V	+25°C	± 0.1	± 1	μA	
				Full		± 5		
I_{off}		V_I or $V_O = 5.5\text{V}$	0	+25°C	± 0.1	± 1	μA	
				Full		± 10		
I_{CC}		$V_I = 5.5\text{V}$ or GND, $I_O = 0$	1.65V to 5.5V	+25°C	0.1	1	μA	
				Full		10		
ΔI_{CC}		One input at $V_{CC} - 0.6\text{V}$, Other inputs at V_{CC} or GND	3V to 5.5V	Full		500	μA	

AC Characteristics

PARAMETER	SYMBOL	TEST CONDITIONS		TEMP	MIN	TYP	MAX	UNIT
Propagation Delay	t_{pd}	$V_{CC}=1.8V\pm 0.15V$	$C_L=30pF, R_L=500\Omega$	Full		21		ns
		$V_{CC}=2.5V\pm 0.2V$	$C_L=30pF, R_L=500\Omega$	Full		7.8		
		$V_{CC}=3.3V\pm 0.3V$	$C_L=50pF, R_L=500\Omega$	Full		5.7		
		$V_{CC}=5V\pm 0.5V$	$C_L=50pF, R_L=500\Omega$	Full		4.2		
Input Capacitance	C_i	$V_{CC}=3.3V$	$V_i=V_{CC}$ or GND	+25°C		4		pF
Power dissipation capacitance	C_{pd}	$V_{CC}=1.8V$	f=10MHz	+25°C		21		pF
		$V_{CC}=2.5V$				22		
		$V_{CC}=3.3V$				22		
		$V_{CC}=5V$				25		

Parameter Measurement Information

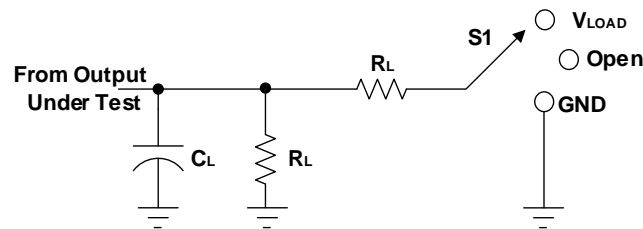

TEST	S1
t_{PLH}/t_{PHL}	Open
t_{PZL}/t_{PZL}	V_{LOAD}
t_{PHZ}/t_{PZH}	GND

V_{CC}	INPUTS		V_M	V_{LOAD}	C_L	R_L	V_{Δ}
	V_I	t_r/t_f					
$1.8V \pm 0.15V$	V_{CC}	$\leq 2ns$	$V_{CC}/2$	$2 \times V_{CC}$	15pF	1M Ω	0.15V
$2.5V \pm 0.2V$	V_{CC}	$\leq 2ns$	$V_{CC}/2$	$2 \times V_{CC}$	15pF	1M Ω	0.15V
$3.3V \pm 0.3V$	3V	$\leq 2.5ns$	1.5V	6V	15pF	1M Ω	0.3V
$5V \pm 0.5V$	V_{CC}	$\leq 2.5ns$	$V_{CC}/2$	$2 \times V_{CC}$	15pF	1M Ω	0.3V

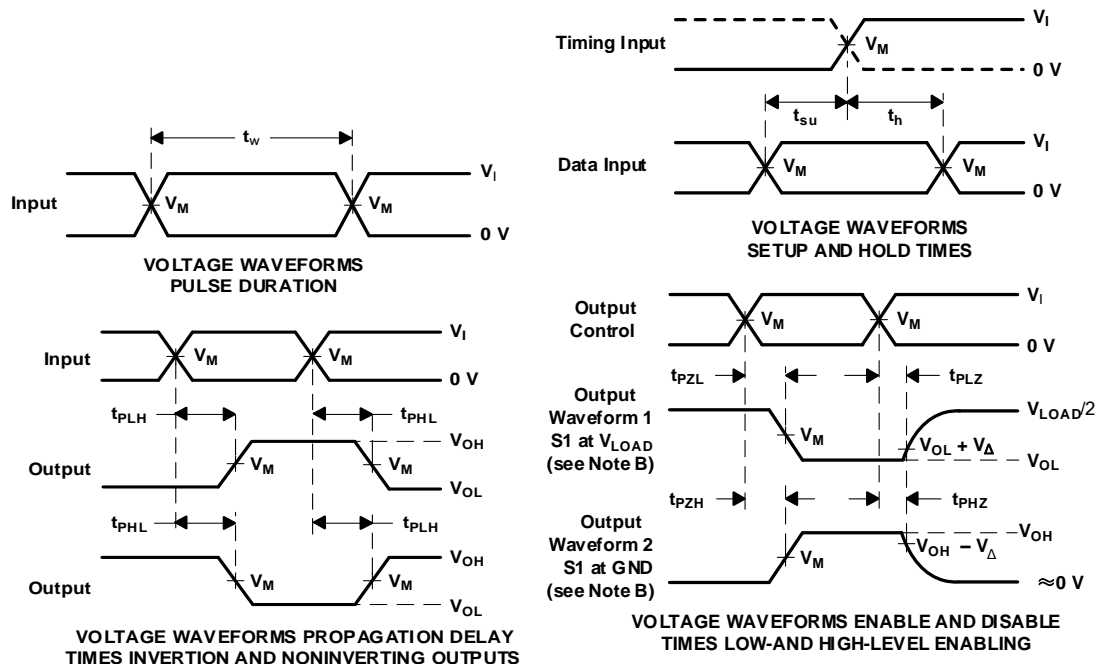

- NOTES: A. C_L includes probe and jig capacitance.
 B. Waveform 1 is for an output with internal conditions such that the output is low, except when disabled by the output control. Waveform 2 is for an output with internal conditions such that the output is high, except when disabled by the output control.
 C. All input pulses are supplied by generators having the following characteristics: $PRR \leq 10 \text{ MHz}$, $Z_O = 50 \Omega$.
 D. The outputs are measured one at a time, with one transition per measurement.
 E. t_{PZL} and t_{PZH} are the same as t_{dis} .
 F. t_{PZL} and t_{PZH} are the same as t_{en} .
 G. t_{PLH} and t_{PHL} are the same as t_{pd} .
 H. All parameters and waveforms are not applicable to all devices.

Figure 1. Load Circuit and Voltage Waveforms

Parameter Measurement Information

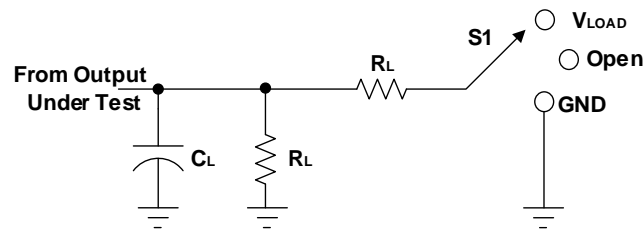

TEST	S1
t_{PLH}/t_{PHL}	Open
t_{PZL}/t_{PZH}	V_{LOAD}
t_{PHZ}/t_{PZH}	GND

V_{CC}	INPUTS		V_M	V_{LOAD}	C_L	R_L	V_{Δ}
	V_I	t_r/t_f					
$1.8V \pm 0.15V$	V_{CC}	$\leq 2ns$	$V_{CC}/2$	$2 \times V_{CC}$	30pF	1k Ω	0.15V
$2.5V \pm 0.2V$	V_{CC}	$\leq 2ns$	$V_{CC}/2$	$2 \times V_{CC}$	30pF	500 Ω	0.15V
$3.3V \pm 0.3V$	3V	$\leq 2.5ns$	1.5V	6V	50pF	500 Ω	0.3V
$5V \pm 0.5V$	V_{CC}	$\leq 2.5ns$	$V_{CC}/2$	$2 \times V_{CC}$	50pF	500 Ω	0.3V

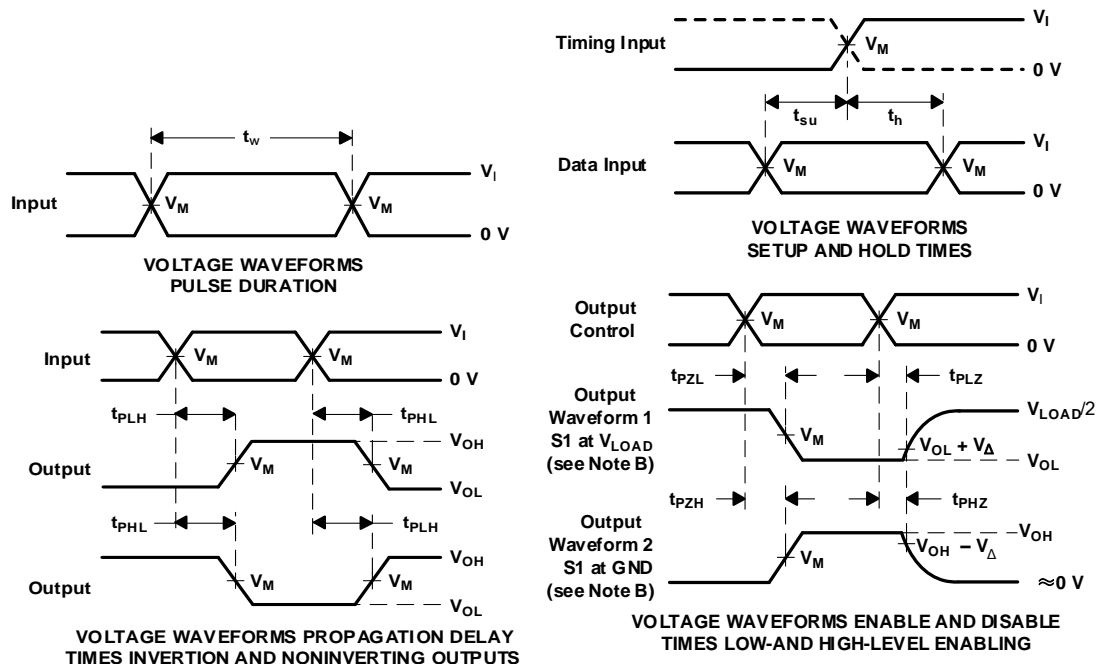

- NOTES: A. C_L includes probe and jig capacitance.
 B. Waveform 1 is for an output with internal conditions such that the output is low, except when disabled by the output control. Waveform 2 is for an output with internal conditions such that the output is high, except when disabled by the output control.
 C. All input pulses are supplied by generators having the following characteristics: $PRR \leq 10 \text{ MHz}$, $Z_O = 50 \Omega$.
 D. The outputs are measured one at a time, with one transition per measurement.
 E. t_{PZL} and t_{PHZ} are the same as t_{dis} .
 F. t_{PZL} and t_{PZH} are the same as t_{en} .
 G. t_{PLH} and t_{PHL} are the same as t_{pd} .
 H. All parameters and waveforms are not applicable to all devices.

Figure 2. Load Circuit and Voltage Waveforms

PACKAGE OUTLINE DIMENSIONS

SOT23-6

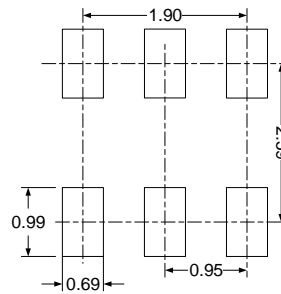
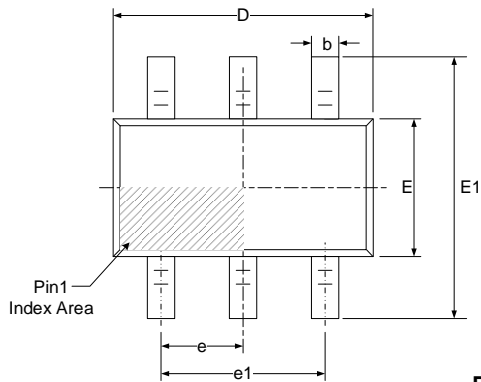
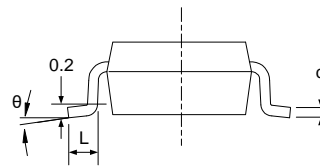
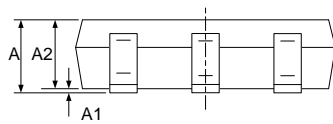
RECOMMENDED LAND PATTERN (Unit: mm)

Symbol	Dimensions In Millimeters		Dimensions In Inches	
	Min	Max	Min	Max
A	1.050	1.250	0.041	0.049
A1	0.000	0.100	0.000	0.004
A2	1.050	1.150	0.041	0.045
b	0.300	0.500	0.012	0.020
c	0.100	0.200	0.004	0.008
D	2.820	3.020	0.111	0.119
E	1.500	1.700	0.059	0.067
E1	2.650	2.950	0.104	0.116
e	0.950(BSC)		0.037(BSC)	
e1	1.800	2.000	0.071	0.079
L	0.300	0.600	0.012	0.024
θ	0°	8°	0°	8°

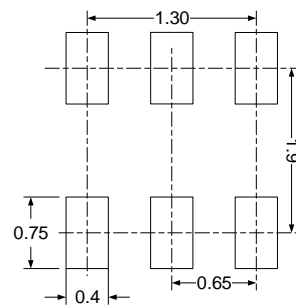
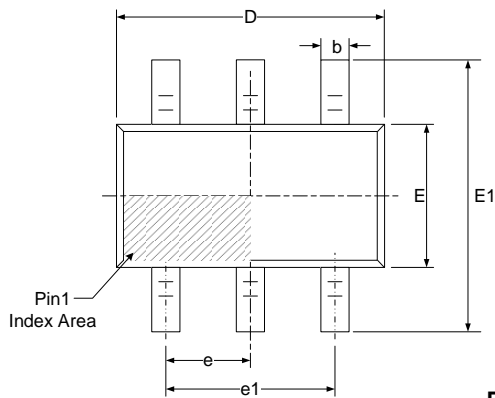
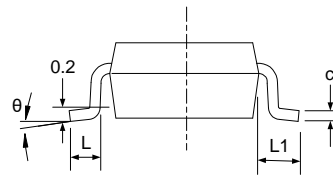
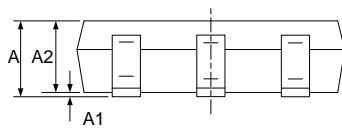
SOT363(SC70-6)

RECOMMENDED LAND PATTERN (Unit: mm)

Symbol	Dimensions In Millimeters		Dimensions In Inches	
	Min	Max	Min	Max
A	0.900	1.100	0.035	0.043
A1	0.000	0.100	0.000	0.004
A2	0.900	1.000	0.035	0.039
b	0.150	0.350	0.006	0.014
c	0.080	0.150	0.003	0.006
D	2.000	2.200	0.079	0.087
E	1.150	1.350	0.045	0.053
E1	2.150	2.450	0.085	0.096
e	0.650(BSC)		0.026(BSC)	
e1	1.300(BSC)		0.051(BSC)	
L	0.260	0.460	0.010	0.018
L1	0.525		0.021	
θ	0°	8°	0°	8°