

# RS6G07 6-channel Buffer and Driver with Open-Drain Outputs

## FEATURES

- **Operating Voltage Range:** 1.65V to 5.5V
- **Low Power Consumption:** 1µA (Max)
- **Operating Temperature Range:** -40°C to +125°C
- **Inputs and Open-Drain Outputs Accept Voltage to 5.5V**
- **High Output Drive:** ±24mA at V<sub>CC</sub>=3.0V
- **PACKAGES:** SOIC-14(SOP14)、TSSOP-14

## APPLICATIONS

- Blu-ray Players and Home Theaters
- Desktops or Notebook PCs
- Digital Video Cameras (DVC)
- Mobile Phones
- Personal Navigation Device (GPS)
- Portable Media Player

### Functional Block Diagram

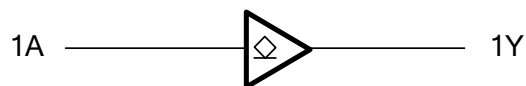

## DESCRIPTION

The RS6G07 6-channel buffer and driver is designed for 1.65V to 5.5V V<sub>CC</sub> operation.

The RS6G07 device is open drain and can be connected to other open-drain outputs to implement active-low wired-OR or active-high wired-AND functions. The device is fully specified for partial-power-down applications using I<sub>off</sub>. The I<sub>off</sub> circuitry disables the outputs, preventing damaging current backflow through the device when it is powered down.

The RS6G07 is available in Green SOIC-14(SOP14) and TSSOP-14 packages. It operates over an ambient temperature range of -40°C to +125°C.

### Device Information (1)

PART NUMBER	PACKAGE	BODY SIZE (NOM)
RS6G07	SOIC-14(SOP14)	8.65mm×3.90mm
	TSSOP-14	5.00mm×4.40mm

(1) For all available packages, see the orderable addendum at the end of the data sheet.

### FUNCTION TABLE

INPUT	OUTPUT
A	Y
L	L
H	Z

H=High Voltage Level

L=Low Voltage Level

Z=High-impedance OFF-state

## Revision History

Note: Page numbers for previous revisions may differ from page numbers in the current version.

VERSION	Change Date	Change Item
A.1	2021/04/20	Initial version completed
A.2	2021/12/20	Added the TAPE AND REEL INFORMATION
A.3	2022/03/29	1. Modify $V_O$ on page 4@A.2 Version 2. Delete $V_{OH}$ on page 7@A.2 Version

## Pin Configuration and Functions

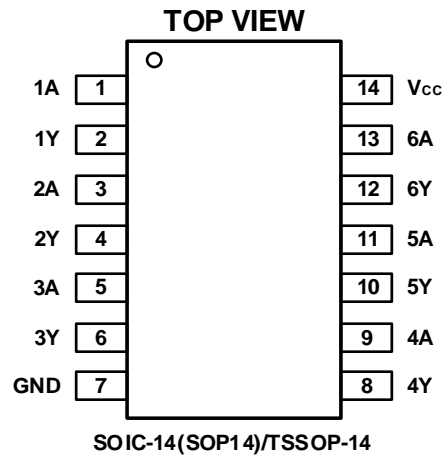

### Pin Description

NAME	PIN	I/O	DESCRIPTION
	SOIC-14(SOP14)/TSSOP-14		
1A	1	I	Input 1
1Y	2	O	Open-drain output 1
2A	3	I	Input 2
2Y	4	O	Open-drain output 2
3A	5	I	Input 3
3Y	6	O	Open-drain output 3
GND	7	P	Ground
4Y	8	O	Open-drain output 4
4A	9	I	Input 4
5Y	10	O	Open-drain output 5
5A	11	I	Input 5
6Y	12	O	Open-drain output 6
6A	13	I	Input 6
V <sub>CC</sub>	14	P	Power pin

## SPECIFICATIONS

### Absolute Maximum Ratings <sup>(1)</sup>

over operating free-air temperature range (unless otherwise noted) <sup>(1)</sup> <sup>(2)</sup>

		MIN	MAX	UNIT
V <sub>CC</sub>	Supply voltage range	-0.5	6.5	V
V <sub>I</sub>	Input voltage range <sup>(2)</sup>	-0.5	6.5	V
V <sub>O</sub>	Output voltage range <sup>(2)</sup>	-0.5	6.5	V
I <sub>IK</sub>	Input clamp current	V <sub>I</sub> <0	-50	mA
I <sub>OK</sub>	Output clamp current	V <sub>O</sub> <0	-50	mA
I <sub>O</sub>	Continuous output current		±50	mA
	Continuous current through V <sub>CC</sub> or GND		±100	mA
T <sub>J</sub>	Junction temperature	-65	150	°C
T <sub>stg</sub>	Storage temperature	-65	150	°C

(1) Stresses beyond those listed under *Absolute Maximum Ratings* may cause permanent damage to the device. These are stress ratings only, and functional operation of the device at these or any other conditions beyond those indicated under *Recommended Operating Conditions* is not implied. Exposure to absolute-maximum-rated conditions for extended periods may affect device reliability.

(2) The input and output negative-voltage ratings may be exceeded if the input and output current ratings are observed.

### ESD Ratings

		VALUE	UNIT	
V <sub>(ESD)</sub>	Electrostatic discharge	Human-body model (HBM)	±8000	V
		Machine model (MM)	±500	V

### Thermal Information:

THERMAL METRIC		RS6G07		UNIT
		14PINS		
		SOIC-14(SOP14)	TSSOP-14	
R <sub>EJA</sub>	Junction-to-ambient thermal resistance	122.2	141.2	°C/W
R <sub>EJC(top)</sub>	Junction-to-case(top) thermal resistance	80.9	78.8	°C/W
R <sub>EJB</sub>	Junction-to-board thermal resistance	80.6	85.8	°C/W
Ψ <sub>JT</sub>	Junction-to-top characterization parameter	40.4	27.7	°C/W
Ψ <sub>JB</sub>	Junction-to-board characterization parameter	80.3	85.5	°C/W
R <sub>EJC(bot)</sub>	Junction-to-case(bottom) thermal resistance	N/A	N/A	°C/W

**PACKAGE/ORDERING INFORMATION**

PRODUCT	ORDERING NUMBER	TEMPERATURE RANGE	PACKAGE LEAD	PACKAGE MARKING <sup>(1)</sup>	PACKAGE OPTION
RS6G07	RS6G07XP	-40°C ~+125°C	SOIC-14(SOP14)	RS6G07	Tape and Reel,4000
	RS6G07XQ	-40°C ~+125°C	TSSOP-14	RS6G07	Tape and Reel,4000

## NOTE:

- (1) There may be additional marking, which relates to the lot trace code information (data code and vendor code), the logo or the environmental category on the device.

## ELECTRICAL CHARACTERISTICS

over recommended operating free-air temperature range (TYP values are at  $T_A = +25^\circ\text{C}$ , unless otherwise noted.) <sup>(1)</sup>

### Recommended Operating Conditions

PARAMETER	SYMBOL	TEST CONDITIONS	MIN	MAX	UNIT
Supply voltage	$V_{CC}$	Operating	1.65	5.5	V
		Data retention only	1.5		
High-level input voltage	$V_{IH}$	$V_{CC}=1.65\text{V to }1.95\text{V}$	$0.65 \times V_{CC}$		V
		$V_{CC}=2.3\text{V to }2.7\text{V}$	1.7		
		$V_{CC}=3\text{V to }3.6\text{V}$	2.2		
		$V_{CC}=4.5\text{V to }5.5\text{V}$	$0.7 \times V_{CC}$		
Low-level input voltage	$V_{IL}$	$V_{CC}=1.65\text{V to }1.95\text{V}$		$0.15 \times V_{CC}$	V
		$V_{CC}=2.3\text{V to }2.7\text{V}$		0.3	
		$V_{CC}=3\text{V to }3.6\text{V}$		0.4	
		$V_{CC}=4.5\text{V to }5.5\text{V}$		$0.15 \times V_{CC}$	
Input voltage	$V_I$		0	5.5	V
Output voltage	$V_O$		0	$V_{CC}$	V
Input transition rise or fall	$\Delta t/\Delta v$	$V_{CC}=1.8\text{V} \pm 0.15\text{V}, 2.5\text{V} \pm 0.2\text{V}$		20	ns/V
		$V_{CC}=3.3\text{V} \pm 0.3\text{V}$		10	
		$V_{CC}=5\text{V} \pm 0.5\text{V}$		5	
Operating temperature	$T_A$		-40	+125	$^\circ\text{C}$

(1) All unused inputs of the device must be held at  $V_{CC}$  or GND to ensure proper device operation.

**DC Characteristics**

PARAMETER		TEST CONDITIONS	V <sub>CC</sub>	TEMP	MIN	TYP	MAX	UNIT
V <sub>OL</sub>		I <sub>OL</sub> = 100μA	1.65V to 5.5V	Full			0.1	V
		I <sub>OL</sub> = 4mA	1.65V				0.45	
		I <sub>OL</sub> = 8mA	2.3V				0.3	
		I <sub>OL</sub> = 16mA	3V				0.4	
		I <sub>OL</sub> = 24mA					0.55	
		I <sub>OL</sub> = 32mA	4.5V				0.55	
I <sub>I</sub>	A or B inputs	V <sub>I</sub> =5.5V or GND	0V to 5.5V	+25°C		±0.1	±1	μA
				Full			±5	
I <sub>off</sub>		V <sub>I</sub> or V <sub>O</sub> =5.5V	0V	+25°C		±0.1	±1	μA
				Full			±10	
I <sub>CC</sub>		V <sub>I</sub> =5.5V or GND, I <sub>O</sub> =0	1.65V to 5.5V	+25°C		0.1	1	μA
				Full			10	
ΔI <sub>CC</sub>		One input at V <sub>CC</sub> -0.6V, Other inputs at V <sub>CC</sub> or GND	3V to 5.5V	Full			500	μA

**AC Characteristics**

PARAMETER	SYMBOL	TEST CONDITIONS		TEMP	MIN	TYP	MAX	UNIT
Propagation Delay	t <sub>pd</sub>	V <sub>CC</sub> =1.8V±0.15V	C <sub>L</sub> =30pF, R <sub>L</sub> =1kΩ	Full		6.4		ns
		V <sub>CC</sub> =2.5V±0.2V	C <sub>L</sub> =30pF, R <sub>L</sub> =500Ω	Full		4.5		
		V <sub>CC</sub> =3.3V±0.3V	C <sub>L</sub> =50pF, R <sub>L</sub> =500Ω	Full		4.2		
		V <sub>CC</sub> =5V±0.5V	C <sub>L</sub> =50pF, R <sub>L</sub> =500Ω	Full		3.7		
Input Capacitance	C <sub>i</sub>	V <sub>CC</sub> =3.3V	V <sub>I</sub> =V <sub>CC</sub> or GND	+25°C		4		pF
Power dissipation capacitance	C <sub>pd</sub>	V <sub>CC</sub> =1.8V	f=10MHz	+25°C		3		pF
		V <sub>CC</sub> =2.5V				3		
		V <sub>CC</sub> =3.3V				4		
		V <sub>CC</sub> =5V				6		

(1) All unused inputs of the device must be held at V<sub>CC</sub> or GND to ensure proper device operation.

# Parameter Measurement Information

## Open-Drain

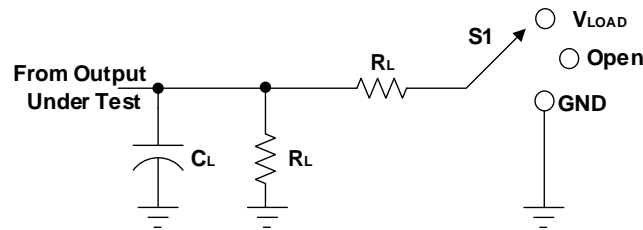

TEST	S1
$t_{PLH}/t_{PHL}$	Open
$t_{PLZ}/t_{PZL}$	$V_{LOAD}$
$t_{PHZ}/t_{PZH}$	GND

$V_{CC}$	INPUTS		$V_M$	$V_{LOAD}$	$C_L$		$R_L$		$V_{\Delta}$
	$V_I$	$t_r/t_f$							
$1.8V \pm 0.15V$	$V_{CC}$	$\leq 2ns$	$V_{CC}/2$	$2 \times V_{CC}$	15pF	30pF	1M $\Omega$	1k $\Omega$	0.15V
$2.5V \pm 0.2V$	$V_{CC}$	$\leq 2ns$	$V_{CC}/2$	$2 \times V_{CC}$	15pF	30pF	1M $\Omega$	500 $\Omega$	0.15V
$3.3V \pm 0.3V$	3V	$\leq 2.5ns$	1.5V	6V	15pF	50pF	1M $\Omega$	500 $\Omega$	0.3V
$5V \pm 0.5V$	$V_{CC}$	$\leq 2.5ns$	$V_{CC}/2$	$2 \times V_{CC}$	15pF	50pF	1M $\Omega$	500 $\Omega$	0.3V

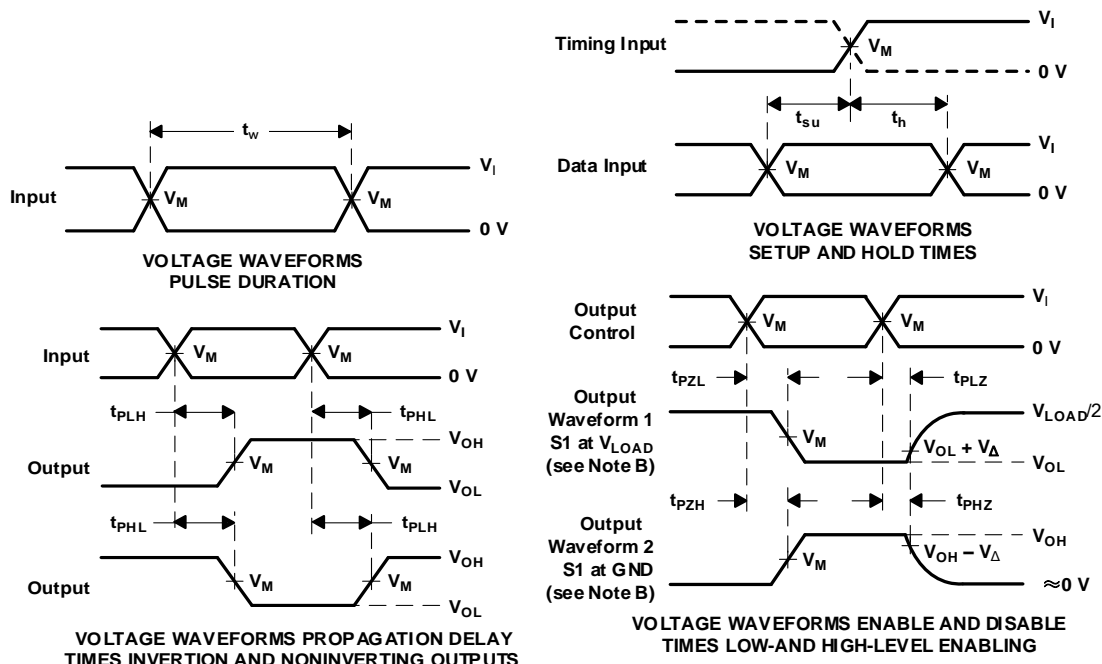

- NOTES:
- A.  $C_L$  includes probe and jig capacitance.
  - B. Waveform 1 is for an output with internal conditions such that the output is low, except when disabled by the output control. Waveform 2 is for an output with internal conditions such that the output is high, except when disabled by the output control.
  - C. All input pulses are supplied by generators having the following characteristics: PRR  $\leq$  10 MHz,  $Z_o = 50 \Omega$ .
  - D. The outputs are measured one at a time, with one transition per measurement.
  - E.  $t_{PLZ}$  and  $t_{PHZ}$  are the same as  $t_{dis}$ .
  - F.  $t_{PZL}$  and  $t_{PZH}$  are the same as  $t_{en}$ .
  - G.  $t_{PLH}$  and  $t_{PHL}$  are the same as  $t_{pd}$ .
  - H. All parameters and waveforms are not applicable to all devices.

**Figure 1. Load Circuit and Voltage Waveforms**



# PACKAGE OUTLINE DIMENSIONS

## SOIC-14(SOP14)

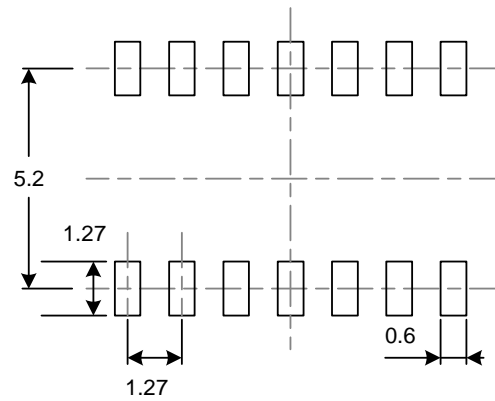
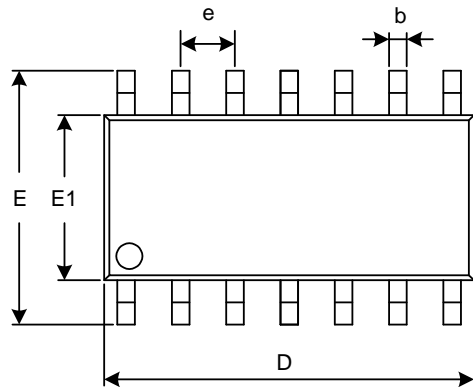

RECOMMENDED LAND PATTERN (Unit: mm)

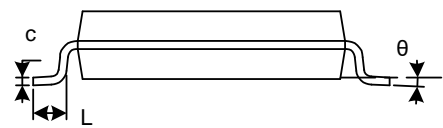
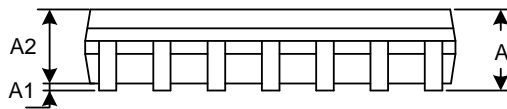

Symbol	Dimensions In Millimeters		Dimensions In Inches	
	Min	Max	Min	Max
A	1.350	1.750	0.053	0.069
A1	0.100	0.250	0.004	0.010
A2	1.350	1.550	0.053	0.061
b	0.310	0.510	0.012	0.020
c	0.100	0.250	0.004	0.010
D	8.450	8.850	0.333	0.348
e	1.270(BSC)		0.050(BSC)	
E	5.800	6.200	0.228	0.244
E1	3.800	4.000	0.150	0.157
L	0.400	1.270	0.016	0.050
$\theta$	0°	8°	0°	8°

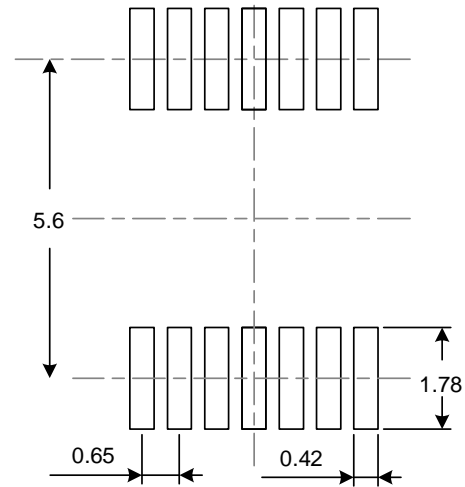
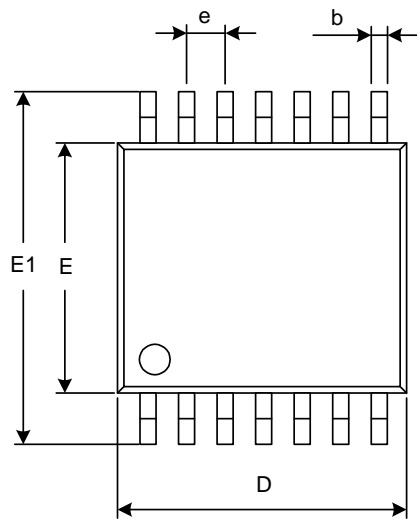
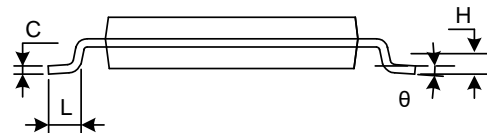
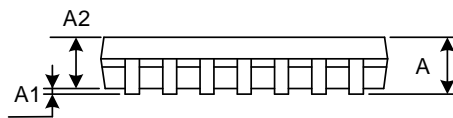
**TSSOP-14**

**RECOMMENDED LAND PATTERN (Unit: mm)**

Symbol	Dimensions In Millimeters		Dimensions In Inches	
	Min	Max	Min	Max
A		1.200		0.047
A1	0.050	0.150	0.002	0.006
A2	0.800	1.050	0.031	0.041
b	0.190	0.300	0.007	0.012
c	0.090	0.200	0.004	0.008
D	4.860	5.100	0.191	0.201
E	4.300	4.500	0.169	0.177
E1	6.250	6.550	0.246	0.258
e	0.650(BSC)		0.026(BSC)	
L	0.500	0.700	0.020	0.028
H	0.25(TYP)		0.01(TYP)	
$\theta$	1°	7°	1°	7°

**TAPE AND REEL INFORMATION**  
**REEL DIMENSIONS**

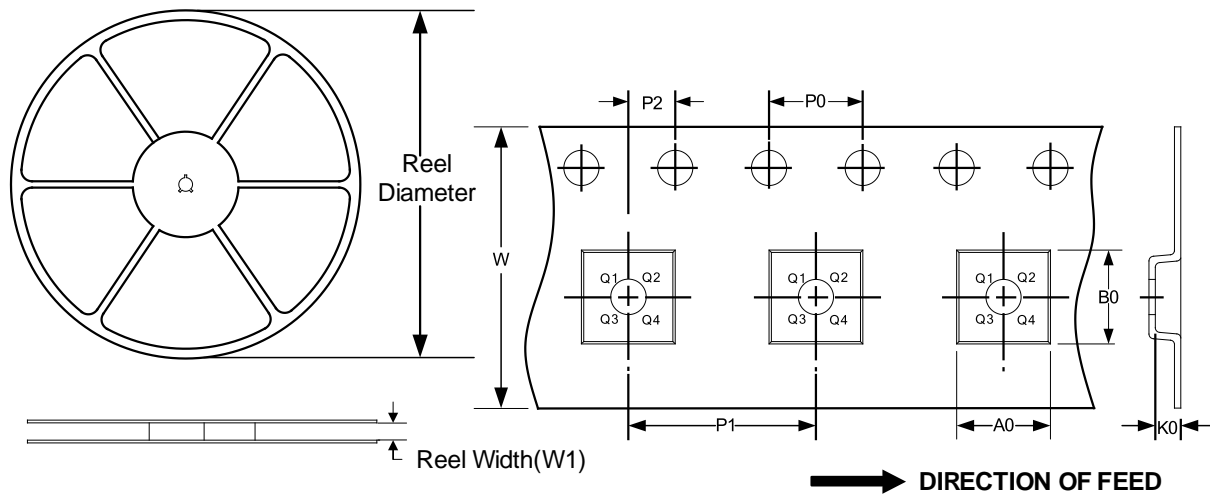
**TAPE DIMENSION**



NOTE: The picture is only for reference. Please make the object as the standard.

**KEY PARAMETER LIST OF TAPE AND REEL**

Package Type	Reel Diameter	Reel Width(mm)	A0 (mm)	B0 (mm)	K0 (mm)	P0 (mm)	P1 (mm)	P2 (mm)	W (mm)	Pin1 Quadrant
SOIC-14(SOP14)	13"	16.4	6.60	9.30	2.10	4.0	8.0	2.0	16.0	Q1
TSSOP-14	13"	12.4	6.95	5.60	1.20	4.0	8.0	2.0	12.0	Q1